

# FURUNO

# RADAR



Model:  
**FAR-21x7 (with 19" LCD)**



Approved

[www.furuno.com](http://www.furuno.com)



## Improved target detection capability and user interface give the best and reliable

The FAR-21x7 series of X- and S-band radar is designed to meet the exacting standards of the International Maritime Organization (IMO) below 10,000 GT.

The display unit employs a 19" LCD which provides an effective picture diameter of larger than 250 mm.

The SXGA monitor provides crisp radar images, which are presented in selectable colors with day and night background colors for easy observation in all lighting conditions. Different colors are assigned for marks, symbols and texts for user-friendly operations.

Target detection is enhanced by sophisticated signal processing techniques. Two guard zones can be set at

required ranges in any sector. Other ship's movements are assessed by advanced target tracking software and alerted by CPA/TCPA data readouts. The FAR-21x7 series can display AIS-equipped ships, when connected with an AIS transponder/receiver.

The X-band radar antenna is available with 4, 6.5, or 8 feet radiator. The S-band radar is also available with the antenna radiator of 12 feet. The S-band radar assures target detection in adverse weather where an X-band is heavily affected by sea or rain clutter. The rotation speed is selectable from 24 rpm for standard X-band radar or 42 rpm for HSC (for S-band radar, 21/26 rpm for standard radar and 45 rpm for HSC application).



performance



**X-band antenna for FAR-2117, 2127**



8 ft antenna  
(4 or 6.5 ft also available)

**S-band antenna for FAR-2137S**



12 ft antenna

<b>FAR-2117</b>	X-band, 12 kW, TR up
<b>FAR-2127</b>	X-band, 25 kW, TR up
<b>FAR-2137S</b>	S-band, 30 kW, TR up



- ▶ Advanced signal processing for improved detection in rough sea
- ▶ LCD display providing crisp radar images



- ▶ Designed to comply with SOLAS carriage requirements for ships below 10,000 GT
- ▶ Up to four radars can be interswitched in the network without an extra device
- ▶ Automatic plotting/tracking of 100 targets manually or automatically acquired
- ▶ Low spurious magnetrons meeting ITU-R unwanted emission standards
- ▶ Displays 1000 AIS-equipped targets

This series of radar comply with the latest IMO and IEC standards:

- IEC 60945 • IEC 62388 • IEC 61162 • IEC 61993
- IMO MSC.191(79) • IMO MSC.192(79) • IMO A.694(17)
- IMO A.813(19) • IMO SN/Circ.243

- ▶ Easy operation by customizable function keys, trackball/wheel palm module and rotary controls



### Full-keyboard Control Unit

The control head has logically arranged controls in a combination of push keys and trackball. Well organized menu ensures that all operations can be done by trackball.



### Palm Control Unit

Alternative to the Full-keyboard Control Unit or additional as a remote operation.

- ▶ 100 Base-TX Ethernet Network System

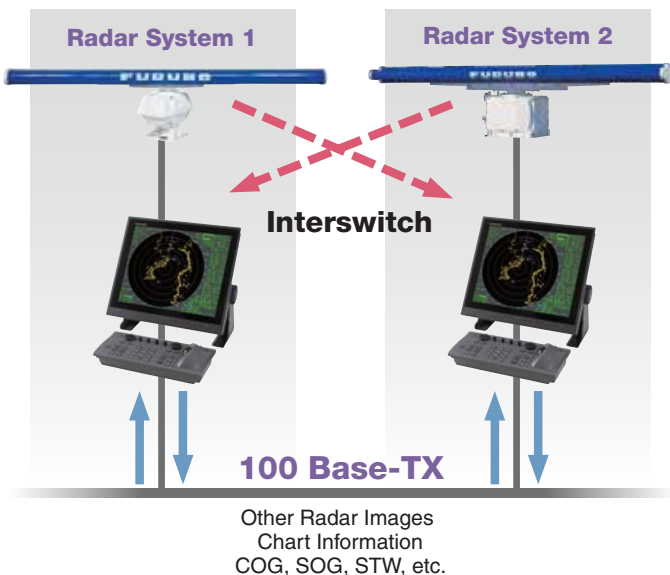

The radar can be connected to an Ethernet network for a variety of user requirements. SOLAS Chapter V as amended requires X- and S-band radar for ships 3000 GT and over. Each of X- and S-band radar can be interswitched without using an extra device. Up to four sets of radar can be interchanged in the network. In addition, the essential navigational information including the electronic chart, L/L, COG, SOG, STW, etc. can be shared in the network.

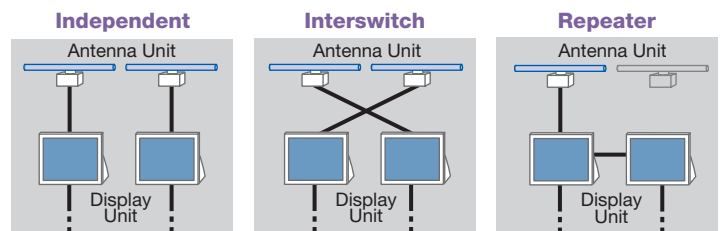

## ▶ TT (ARPA) /AIS

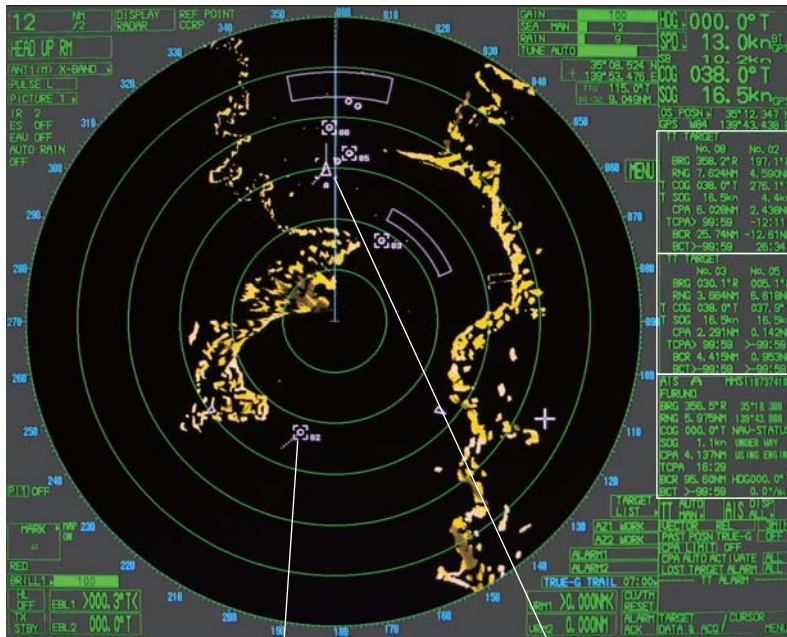

**Targets automatically acquired**

**AIS-equipped target selected for data reading.**

OS data cell	
DATA Cell 1	Water temp, Depth, Wind
Tracking data	
DATA Cell 2	Magnify
Tracking data	
DATA Cell 3	AIS Information
AIS Information	

## Data Display

A variety of navigational information, own ship status, radar plotting data, wind, water temperature and information from other shipborne sensors are displayed on the cells. These selected targets are marked with a square symbol on the radar display. Magnify is a special feature of the FURUNO radars FAR-21x7 series. This looks like a delayed-sweep zoom which IMO strictly prohibits, but where Administration accepts, the Magnify feature enlarges part of radar display for special maritime activities.

## Target Association (Fusion)

An AIS-equipped ship may be displayed by both AIS and TT symbols. This is because the AIS position is measured by a GPS in L/L while the TT symbol blip and data are measured by range and bearing from own ship and located on the radar PPI.

When the symbols are within an operator-set criteria, the TT symbol is merged in the AIS symbol. The criteria are determined by the differences in range, bearing, course, speed, etc.

## Marks and Symbols for TT (ARPA) and AIS

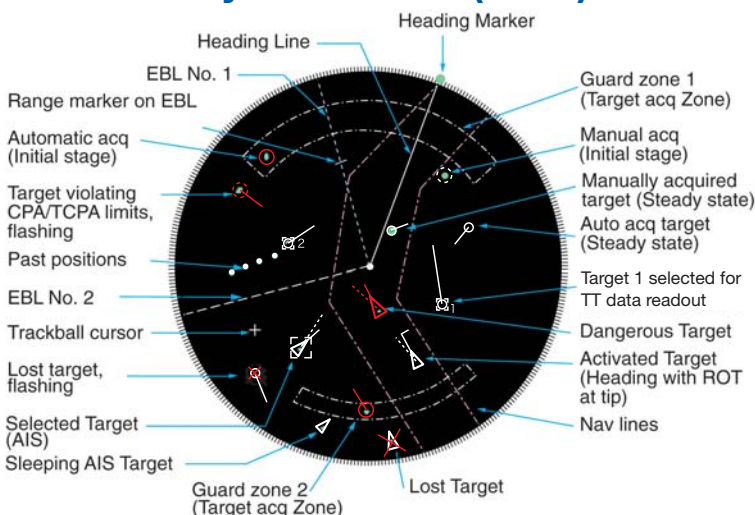

## AIS information

### Static Data

- MMSI (Maritime Mobile Service Identity)
- IMO number (Where available)
- Call sign & name
- Length and beam
- Type of ship
- Location of position-fixing antenna on the ship

### Voyage related data

- Ship's draught
- Hazardous cargo (type)
- Destination and ETA (at masters discretion)

### Dynamic data

- Ship's position with accuracy indication and integrity status
- UTC
- Course over ground (COG)
- Speed over ground (SOG)
- Heading
- Navigation status (manual input)
- Rate of turn (where available)
- Update rates dependent on speed and course alternation (2 s – 3 min)

### Short safety-related messages

- Free messages

## ► Guard Zones

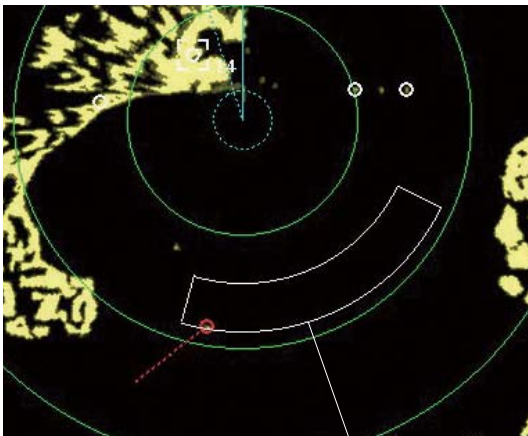

Guard Zones

### Automatic Acquisition Zone

Two automatic acquisition zones may be set in a sector or any form. They also act as suppression zones, avoiding unnecessary overloading to the processor and clutter by disabling automatic acquisition and tracking outside them. Targets in an automatic acquisition zone appear as inverse triangles.

The operator can manually acquire important targets without restriction.

### CPA Alarm Zone

Target tracking symbol changes to a triangle when its predicted course (vector) violates the operator set CPA/TCPA. The operator can readily change the vector lengths to evaluate target movement trend.

### Guard Zones and Anchor Watch Zone

Guard Zones generate visual and audible alarms when targets enter the operator set zones. One of Guard Zones may be used as an anchor watch to alert the operator when own ship or targets drift away from the set zone.

## ► Target Trails

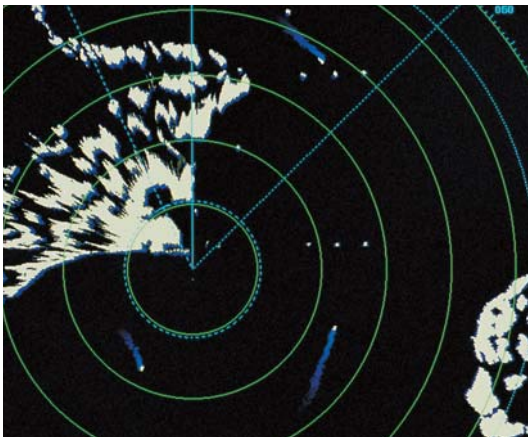

The target trails feature generates monotone or gradual shading afterglow on all objects on the display. The shading afterglow paints the display just like on an analog PPI. The monotone trails are useful to show own ship movement and other ship tracks in a specific fishing operation. The trail time is adjustable for 15, 30 s, 1, 3, 6, 15, 30 min or continuous. The target trails are indicated in a different color from background. The unique feature in this radar is a choice of True or Relative mode in Relative Motion (only True in TM).

## ► Radar Map

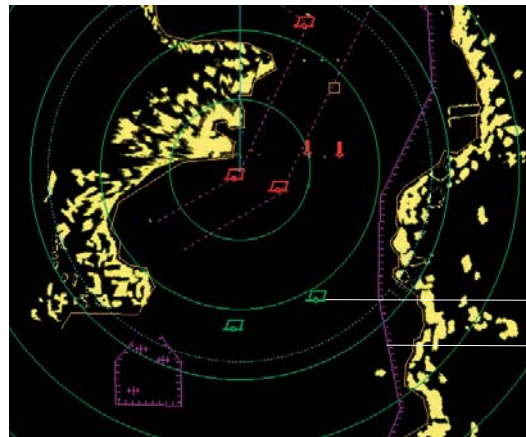

Map Marks  
Map Lines

Up to 200 waypoints and up to 30 routes can be stored. Each route may contain up to 30 waypoints. A radar map is a combination of map lines and marks whereby the user can define and input the navigation area, route planning and monitoring data. The radar map has the capacity of 3,000 points for lines and marks. The map data can be stored and recalled for repeated use on a routine navigation area.

## ► Chart Overlay



This radar incorporates a VideoPlotter that allows to display electronic charts, plot own and other ship's track, enable entry of waypoints/routes, and make a radar map. Chart is displayed in combination of radar images. (For non-SOLAS ships only)

## ► Presentation Colors

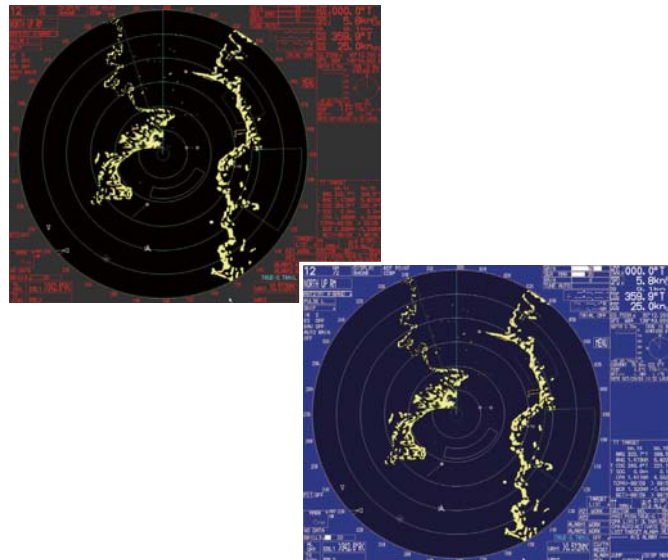

## Product Name MARINE RADAR/ARPA

### Antenna Radiators

#### 1. Type

Slotted waveguide array

#### 2. Beamwidth and sidelobe attenuation

Radiator Type	X-Band			S-Band
	XN-12AF	XN-20AF	XN-24AF	SN-36AF
Length	4 ft	6.5 ft	8 ft	12 ft
Beamwidth(H)	1.9	1.23	0.95	1.8
Beamwidth(W)	20	20	20	25
Sidelobe (within 10)	-24 dB	-28 dB	-28 dB	-24 dB
Sidelobe (outside 10)	-30 dB	-32 dB	-32 dB	-30 dB

#### 3. Rotation

Rotation	X-Band		S-Band	
	24 rpm	42 rpm	21/26 rpm	45 rpm
Gear Box	RSB-096	RSB-097	RSB-098 RSB-099	RSB-100 RSB-101 RSB-102

### RF Transceiver

#### 1. Frequency

X-band: 9410 MHz 30 MHz

S-band: 3050 MHz 30 MHz

#### 2. Output power

	FAR-2117	FAR-2127	FAR-2137S
Output Power	12 kW	25 kW	30 kW
Transceiver	RTR-078	RTR-079	RTR-080

#### 3. Pulselength/PRR

Range scale (nm)	Pulselength (s)	PRR (Hz)
0.125, 0.25	0.07	3000
0.5	0.07, 0.15	3000
0.75, 1.5	0.07, 0.15, 0.3	3000, 1500
3	0.15, 0.3, 0.5, 0.7	3000, 1500, 1000
6	0.3, 0.5, 0.7, 1.2	1500, 1000, 600
12, 24	0.5, 0.7, 1.2	1000, 600
48, 96	1.2	600

#### 4. I.F.

60 MHz, Logarithmic

#### 5. Bandwidth

Short pulse: 40 MHz

Middle pulse: 10 MHz

Long pulse: 3 MHz

### Radar Display

#### 1. Display

19" color LCD (SXGA 1280 x 1024 pixels),

376.3 (H) x 301.1 (V) mm,

Effective display diameter: 291 mm

Echo Color: Yellow, green or white in 32 levels

#### 2. Range scales and ring intervals (nm)

Range: .125, .25, .5, .75, 1.5, 3, 6, 12, 24, 48, 96

Ring: .025, .05, .1, .25, .25, .5, 1, 2, 4, 8, 16

#### 3. Minimum range

22 m

#### 4. Range discrimination

26 m

#### 5. Range ring accuracy

0.2 %

#### 6. Presentation modes

Head-Up, Cursor-gyro, Course-Up, North-Up, North-Up True

Motion (sea or ground stabilization)

#### 7. Heading information

Furuno GPS compass is a recommendable heading sensor as a backup of a gyrocompass.

Confirm with your Administrations.

#### 8. Parallel index lines

1, 2, 3 or 6 lines (menu selectable)

#### 9. Radar map

20,000 points to create coastlines, own ship safety contour, isolated underwater dangers, buoys, traffic routing systems, prohibited areas, fairways as required by IMO.

### Target Tracking

#### 1. Acquisition

100 targets (e.g. manually 50, automatically 50) in 0.2-24 nm

#### 2. Tracking

Automatic tracking of all acquired targets

#### 3. Guard zone

Two zones, one of them 0.5 nm depth

#### 4. Past positions

5 or 10 past positions on all targets

#### 5. Collision warning

CPA limit: 0.2 - 10 nm, TCPA limit: 0 - 99 min.

#### 6. Trial maneuver

Dynamic or static, with selected delay time.

### AIS Display (Data input from AIS is required)

#### 1. Symbols

Sleeping, Activated, Dangerous, Selected, Lost targets

#### 2. Number of targets

1,000 targets max.

#### 3. Data indication

Basic and expanded data

### Power Supply (specify when ordering)

#### 1. Processor Unit

100-115/220-230 VAC, 1ø, 50/60 Hz,

FAR-2117: 7.6 A (8.5 A for HSC application) at 24 VDC,

FAR-2127: 8.8 A (9.7 A for HSC application) at 24 VDC

FAR-2137S: 3.0 A for 100-115 VAC

1.5 A for 220-230 VAC

440 VAC, 1ø, 50/60 Hz with optional transformer RU-1803

#### 2. Display Unit

100-230 VAC, 1ø, 50/60 Hz, 0.7 A

440 VAC, 1ø, 50/60 Hz with optional transformer RU-1803

#### 3. Antenna Unit

FAR-2137S:

200/380 VAC, 3.0/1.5 A, 3ø, 50 Hz; 220/440 VAC, 3.0/1.5 A (3.5/1.7 A for HSC application), 3ø, 60 Hz

115 VAC, 3ø, 60 Hz with optional transformer RU-5693

230 VAC, 3ø, 50 Hz with optional transformer RU-6522

440 VAC, 3ø, 50 Hz with optional transformer RU-5466-1

### EQUIPMENT LIST

#### Standard

1. Display Unit MU-190
2. Processor Unit RPU-013
3. Full-keyboard Control Unit RCU-014  
Trackball Control Unit (Palm Control Unit)  
RCU-015 (Specify when ordering)
4. Antenna Unit with cable, 15/20/30/50/100 m  
(Specify when ordering)
5. Power Supply unit PSU-007 for FAR-2137S
6. Standard Spare Parts and Installation Materials

#### Option

1. Performance Monitor PM-31 for FAR-2117/2127  
PM-51 for FAR-2137S (Specify when ordering)
2. Remote Control Unit RCU-016
3. Gyro Interface GC-10 (built in Processor Unit)
4. DVI-Analog RGB Conversion Kit (Buffer board built in) OP-03-180
5. RGB Connector DSUB-BNC-1 (for VDR)
6. Card Interface Unit CU-100
7. Transformer RU-1803/5466-1/5693/6522
8. Rectifier RU-3424/1746B
9. Junction Box RJB-001
10. Antenna Cable RW-9600
11. External Alert Buzzer OP03-21
12. Hand Grip FP03-09840
13. Bracket FP03-09820
14. Hub HUB-100

# INTERCONNECTION DIAGRAM

— Option or Shipyard Supply  
 - - - - - Power  
 Specify power supply when ordering  
 \*Optional transformer required

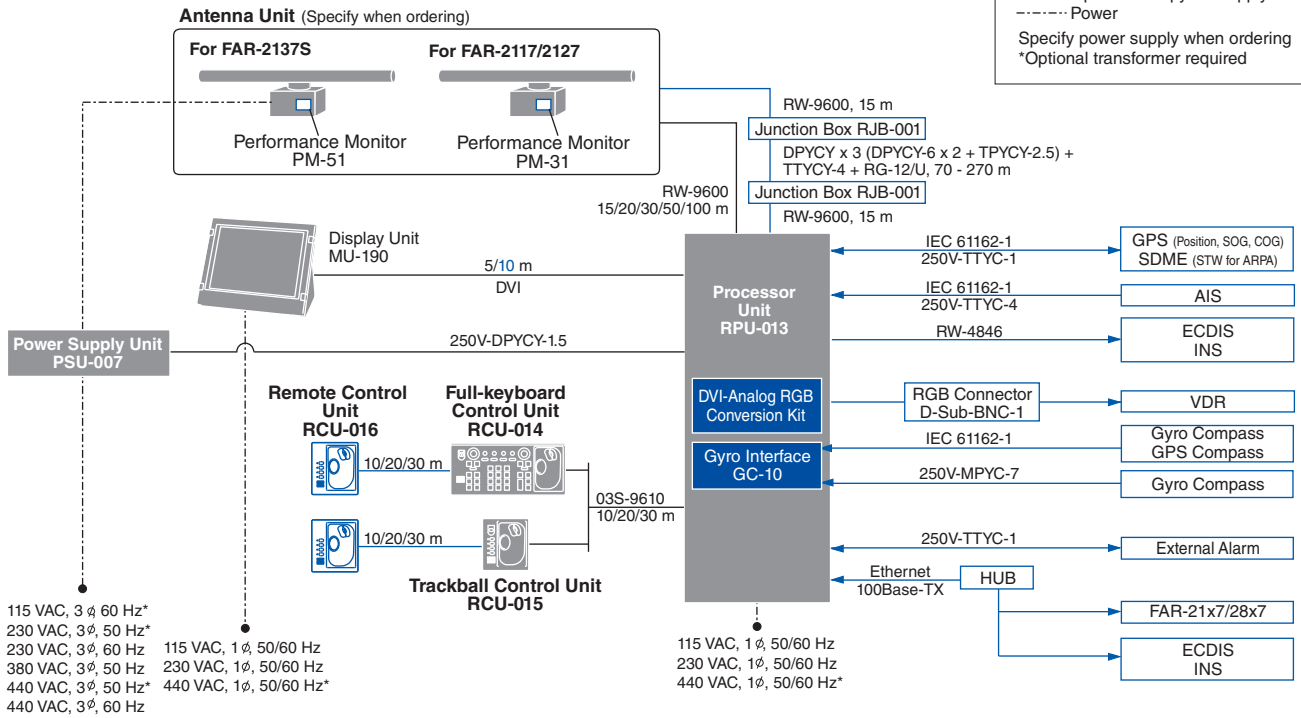

## Antenna Unit for FAR-2117/2127

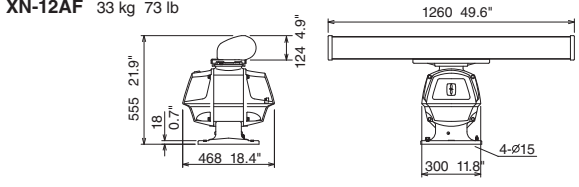

## XN-20AF 39 kg 86 lb XN-24AF 42 kg 93 lb

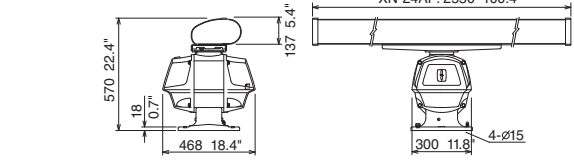

## Antenna Unit for FAR-2137S

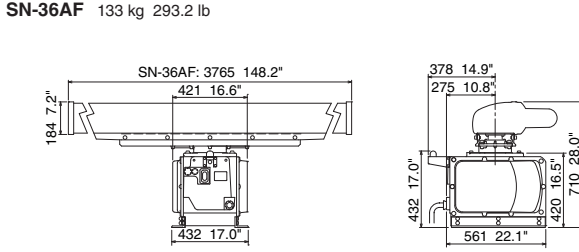

## Processor Unit

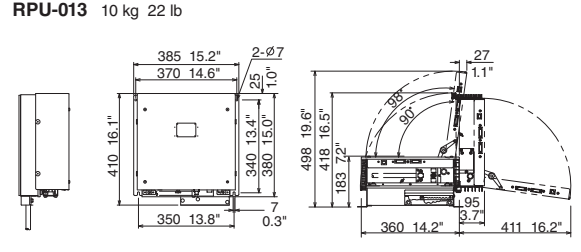

## Display Unit

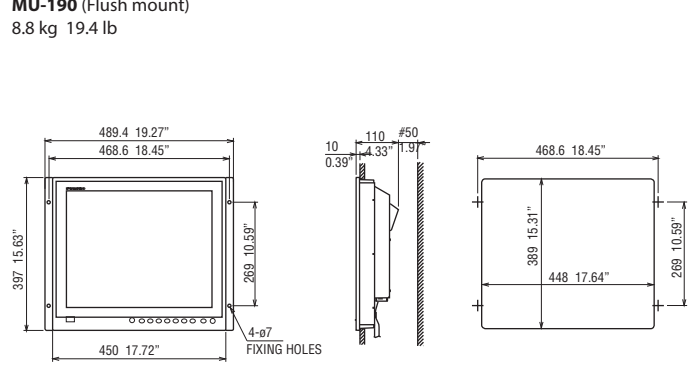

## Full-keyboard Control Unit

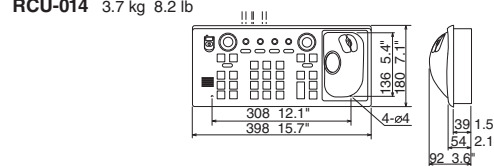

## Trackball Control Unit

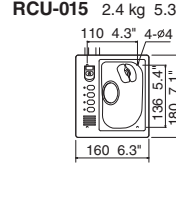

## Remote Control Unit

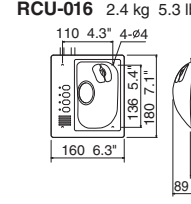

All brand and product names are registered trademarks, trademarks or service marks of their respective holders.  
 SPECIFICATIONS SUBJECT TO CHANGE WITHOUT NOTICE