

FURUNO

OPERATOR'S MANUAL

NAVIGATIONAL ECHO SOUNDER

MODEL **FE-700**

 **FURUNO ELECTRIC CO., LTD.**

www.furuno.co.jp



(Elemental Chlorine Free)

The paper used in this manual
is elemental chlorine free.

FURUNO ELECTRIC CO., LTD.

9-52 Ashihara-cho,
Nishinomiya, 662-8580, JAPAN

Telephone : +81-(0)798-65-2111

Fax : +81-(0)798-65-4200

All rights reserved.

Printed in Japan

Pub. No. OME-23660-T

(HIMA) FE-700

• FURUNO Authorized Distributor/Dealer

A : JAN . 2000

T : JUL . 27 , 2009



* 0 0 0 8 0 8 9 0 8 1 7 *

IMPORTANT NOTICES

General

- The operator of this equipment must read and follow the descriptions in this manual. Wrong operation or maintenance can cancel the warranty or cause injury.
- Do not copy any part of this manual without written permission from FURUNO.
- If this manual is lost or worn, contact your dealer about replacement.
- The contents of this manual and equipment specifications can change without notice.
- The example screens (or illustrations) shown in this manual can be different from the screens you see on your display. The screens you see depend on your system configuration and equipment settings.
- Save this manual for future reference.
- Any modification of the equipment (including software) by persons not authorized by FURUNO will cancel the warranty.
- All brand and product names are trademarks, registered trademarks or service marks of their respective holders.

How to discard this product

Discard this product according to local regulations for the disposal of industrial waste. For disposal in the USA, see the homepage of the Electronics Industries Alliance (<http://www.eiae.org/>) for the correct method of disposal.

How to discard a used battery

Some FURUNO products have a battery(ies). To see if your product has a battery(ies), see the chapter on Maintenance. Follow the instructions below if a battery(ies) is used.

In the European Union

The crossed-out trash can symbol indicates that all types of batteries must not be discarded in standard trash, or at a trash site. Take the used batteries to a battery collection site according to your national legislation and the Batteries Directive 2006/66/EU.



In the USA

The Mobius loop symbol (three chasing arrows) indicates that Ni-Cd and lead-acid rechargeable batteries must be recycled. Take the used batteries to a battery collection site according to local laws.

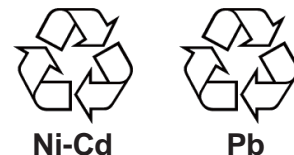

In the other countries

There are no international standards for the battery recycle symbol. The number of symbols can increase when the other countries make their own recycling symbols in the future.



SAFETY INSTRUCTIONS



WARNING



ELECTRICAL SHOCK HAZARD
Do not open the equipment.

Only qualified personnel should work inside the equipment.

Immediately turn off the power at the switchboard if water leaks into the equipment.

Continued use of the equipment can cause fire or electrical shock. Contact a FURUNO agent for service.

Do not disassemble or modify the equipment.

Fire, electrical shock or serious injury can result.

Immediately turn off the power at the switchboard if the equipment is emitting smoke or fire.

Continued use of the equipment can cause fire or electrical shock. Contact a FURUNO agent for service.

Make sure no rain or water splash leaks into the equipment.

Fire or electrical shock can result if water leaks in the equipment.

Use the proper fuse.

Use of a wrong fuse can result in equipment damage and void the warranty.



CAUTION

Do not power the equipment when the transducer is in air.

The transducer may become damaged.

WARNING LABEL

A warning label is attached to the equipment. Do not remove the label. If the label is missing or illegible, contact a FURUNO agent or dealer.

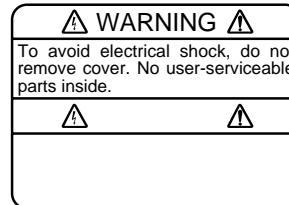

Name: Warning Label (1)

Type: 86-003-1011-1

Code No.: 100-236-231

About the TFT LCD

The TFT LCD is constructed using the latest LCD techniques, and displays 99.99% of its pixels. The remaining 0.01% of the pixels may drop out or blink, however this is not an indication of malfunction.

CONTENTS

FOREWORD	iv	3.3 System Menu 2	12
A Word to FE-700 Owners.....	iv	3.4 System Menu 3	13
Features.....	iv	4 ECHO QUALITY SETTING	14
SYSTEM CONFIGURATION	v	4.1 Demonstration Display	14
SPECIFICATIONS OF FE-700	SP-1	4.2 Bottom Level	14
1 OPERATION	1	4.3 TVG Level	15
1.1 Control Description.....	1	4.4 Echo Offset.....	15
1.2 Indications, Markers	2	5 OPERATION OF DIGITAL DEPTH	
1.3 Turning On/Off.....	3	INDICATOR FE-720 (OPTION)	16
1.4 Tone and Brilliance	3	5.1 Basic Operation.....	16
1.5 Panel Dimmer.....	3	5.2 Menu Operation	17
1.6 Display Mode.....	4	5.3 Diagnosis	18
1.7 Range Scale.....	7	5.4 Factory Setting.....	18
1.8 Gain Control	7	6 MAINTENANCE,	
1.9 Automatic Operation.....	7	TROUBLESHOOTING	19
1.10 Picture Colors	7	6.1 Checking	19
1.11 Shallow Depth Alarm	8	6.2 Cleaning the Display Unit.....	19
1.12 Draft.....	8	6.3 Transducer Maintenance	19
2 MENU OPERATION.....	9	6.4 Replacing the Fuse, Battery.....	19
2.1 Menu Overview	9	6.5 Troubleshooting.....	20
2.2 Suppressing Low Level Noise	9	6.6 Diagnostic Test.....	21
2.3 Suppressing Interference	9	6.7 Test Pattern	21
2.4 Picture Advance	10	6.8 Clearing the Memory.....	22
2.5 Trend	10	7 MENU TREE	23
2.6 Interval.....	10	8 DIGITAL INTERFACE (IEC 61162-1	
2.7 Choosing the Transducer	10	EDITION 2).....	24
3 SYSTEM MENU.....	11	9 PARTS LOCATION, PARTS LIST ..	32
3.1 System Menu	11	Declaration of Conformity	
3.2 System Menu 1	12		

FOREWORD

A Word to FE-700 Owners

Thank you for purchasing this navigational echo sounder. We are confident you will discover why FURUNO has become synonymous with quality and reliability.

Dedicated in the design and manufacture of marine electronics equipment for over 60 years, FURUNO Electric Company has gained an unrivaled reputation as a world leader in the industry. This is the result of our technical excellence as well as our worldwide distribution and service network.

Please carefully read and follow the safety information and operating and maintenance instructions set forth in this manual before attempting to operate the equipment and conduct any maintenance. Your navigational echo sounder will perform to the utmost of its ability only if it is operated and maintained in accordance with the correct procedures.

This equipment is designed, produced and documented by FURUNO ELECTRIC CO., LTD., complying with ISO 9001 standards as certified by the Lloyd's Register of Quality Assurance System.

Features

The FURUNO FE-700 is comprised of display unit and transducer unit. Echo sounding data is displayed on the bright 6.5-inch color TFT (Thin Film Transistor) LCD display.

The main features of the FE-700 are

1. Complies with the IMO and ISO standards MSC.74(69) Annex 4 and ISO9875.
2. Cost-effective; no paper, no consumables; high accuracy and high reliability - no rotating gears and belts as in the paper echo sounders
3. High-contrast 6.5-inch color LCD display featuring a wide viewing angle and adjustable brightness.
4. Wide variety of modes with never-get-lost default position.
5. Automatic function permits unattended adjustment of range, gain, and pulselength. The range scale and gain automatically change to display the bottom.
6. Position, course, speed, time are repeated from the external devices.
7. Alarms: shallow water, bottom lost, power drop
8. The dual frequency display can be shown by using the optional matching box MB-1200.

SYSTEM CONFIGURATION

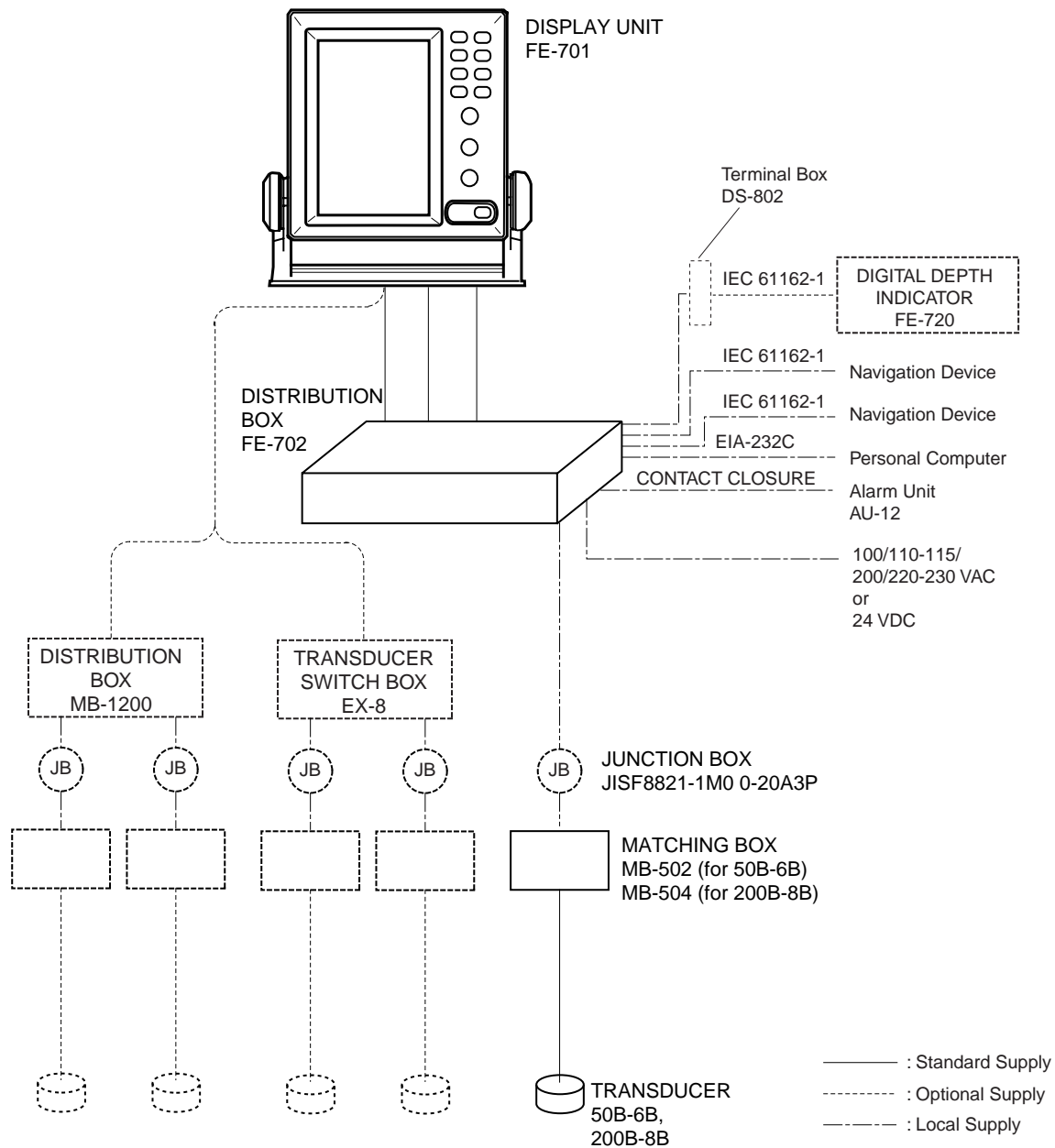

FE-700 system configuration

PRINCIPLE OF OPERATION

The FE-700 uses ultrasonic pulses to detect the seabed and other underwater objects. The display unit contains all basic electric circuits and logic processor. Electrical pulses are converted into acoustical energy in the transducer fitted on the ship's hull. The processor measures the time of pulses travelling between the seabed and transducer and displays the water depths in the graphical form or other forms.

The transducers have a specific beam width with respect to their working frequency, 50 kHz or 200 kHz. The high frequency has a narrow beamwidth and is immune to aeration when the ship is going astern or in rough weather. The low frequency has a wide beamwidth and more powerful sounding capability.

**SPECIFICATIONS OF NAVIGATIONAL ECHO SOUNDER
FE-700**

1 GENERAL

- 1.1 Transmit frequency 50 kHz, 200 kHz, or 50/200 kHz alternating transmit
- 1.2 Output power 600 Wrms
- 1.3 Beam width 50B-6B (50 kHz): 35°, 200B-8B (200 kHz): 6°
- 1.4 Basic display range

Unit	Range							
	1	2	3	4	5	6	7	8
Meter	5	10	20	40	100	200	400	800
Feet	15	30	60	120	300	600	1500	2500
Fathom	3	5	10	20	50	100	200	400

*Default settings; it could be customized for use w/o range 3 and 6.

- 1.4 Accuracy ±2.5% on any range
- 1.5 Minimum range 0.5 m (200 kHz), 2.0 m (50 kHz)
- 1.6 Draft 0 to 30 m in 0.1 m steps, default 0 m
- 1.7 Pulse repetition rate (PRR)

Depth (m)	P/L (ms)	PRR (pulse/min)
5, 10, 20	0.25	750
40	0.38	375
100	1.00	150
200	2.00	75
400,800	3.60	42

2 DISPLAY UNIT

- 2.1 Graphical display 6.5-inch color TFT LCD, 320 x 234 pixels
- 2.2 Echo colors 8 colors or 8 level monochrome
- 2.3 Display area 133 x 97 mm
- 2.4 Display mode
 - “NAV”: Basic echo presentation with the depth below transducer (or keel)
 - “DBS”: Echo presentation with the depth below sea surface
 - “HISTORY”: Historical Echo presentation with the depth
 - “LOGBOOK”: Echo presentation with the pop-up table showing
Time, Depth and L/L* data memorized at preset interval
 - “OS DATA”: Echo presentation with the pop-up table of present
navigational data; L/L*, course*, speed*, time, depth
 - “HELP”: Echo presentation with the help menu and note
 - “MENU”: Echo presentation with the user menu
- 2.5 Picture advance speed
 - Slow mode 15 minutes or more
 - Fast mode Picture advance range

Range (m)	5	10	20	40	100	200	400	800
Interval (min.)	1.8			8		20	30	

- 2.6 User setting Gain, Range, Alarm, Draft, Brilliance, Dimmer, Color, Auto
- 2.7 Auto set mode Gain, range and clutter will be automatically adjusted.
- 2.8 Alarm Shallow water (default 20 m), Bottom lost, Power drop
- 2.9 Logbook display Depth, Internal clock, L/L*

1 hour at 5 sec Interval, 12 hours at 1 minute interval and 24 hours at 2 minutes interval

*: External navigational sensor required.

3 DIGITAL DEPTH INDICATOR

- 3.1 Display 4.5-inch monochrome LCD
 3.2 Depth indication **. * m (less than 100m), **** m (100 m or more)

4 INTERFACE

- 4.1 Serial input data IEC61162-1, current loop; 1 port
 RMA: L/L, Ground track speed, Track
 RMC: L/L (GPS), Ground track speed, Track, Time
 GGA/GLL: L/L
 VTG: Ground track speed, Track (true/magnetic selected on menu)
 ZDA: Time
- 4.2 Serial output data IEC61162-1, output period: 1 sec.; 3 outputs/ 1 port
 SDDPT: Depth (m), Draft (m)
 SDDBT: Depth (ft, m, fa) below transducer
 SDDBK: Depth (ft, m, fa) below keel
 SDDBS: Depth (ft, m, fa) below sea surface
- 4.3 Serial I/O data RS-232C, 1 port
 Output Depth, Clock, L/L, Ship's speed, Course
 Input Control command for PC
- 4.4 Alarm (Depth, Power) Contact closure signal, normal open or normal close,
 250 VAC/ 200 VDC, 3A max.

5 POWER SUPPLY

- 5.1 Distribution box (FE-720) 100/110-115/200/220-230 VAC: 0.2 A max., 1 phase, 50/60Hz or
 24 VDC: 0.6 A
 5.2 Digital depth indicator 24 VDC, 0.15A

6 ENVIRONMENTAL CONDITION

- 6.1 Temperature -15°C to +55°C
 6.2 Relative humidity 93% at +40°C
 6.3 Degree of protection
 Display unit, Digital depth indicator IPX5
 Distribution box, Matching box IPX2
- 6.4 Vibration IEC 60945
 6.5 EMC IEC 60945

7 COATING COLOR

- 7.1 Display unit Panel: N3.0, Chassis: 2.5GY5/1.5 (fixed)
 7.2 Digital depth indicator Panel: N3.0, Chassis: 2.5GY5/1.5 (fixed)
 7.3 Distribution box (FE-720) 2.5GY5/1.5 or 7.5BG7/2
 7.4 Distribution box (MB-1200) N3.0
 7.5 Matching box 2.5G7/2 (fixed)

1 OPERATION

1.1 Control Description

All operation of the FE-700 is carried out with the controls on the front panel of the display unit. Rotary controls respond immediately to your command but some touch keys require the successive operation.

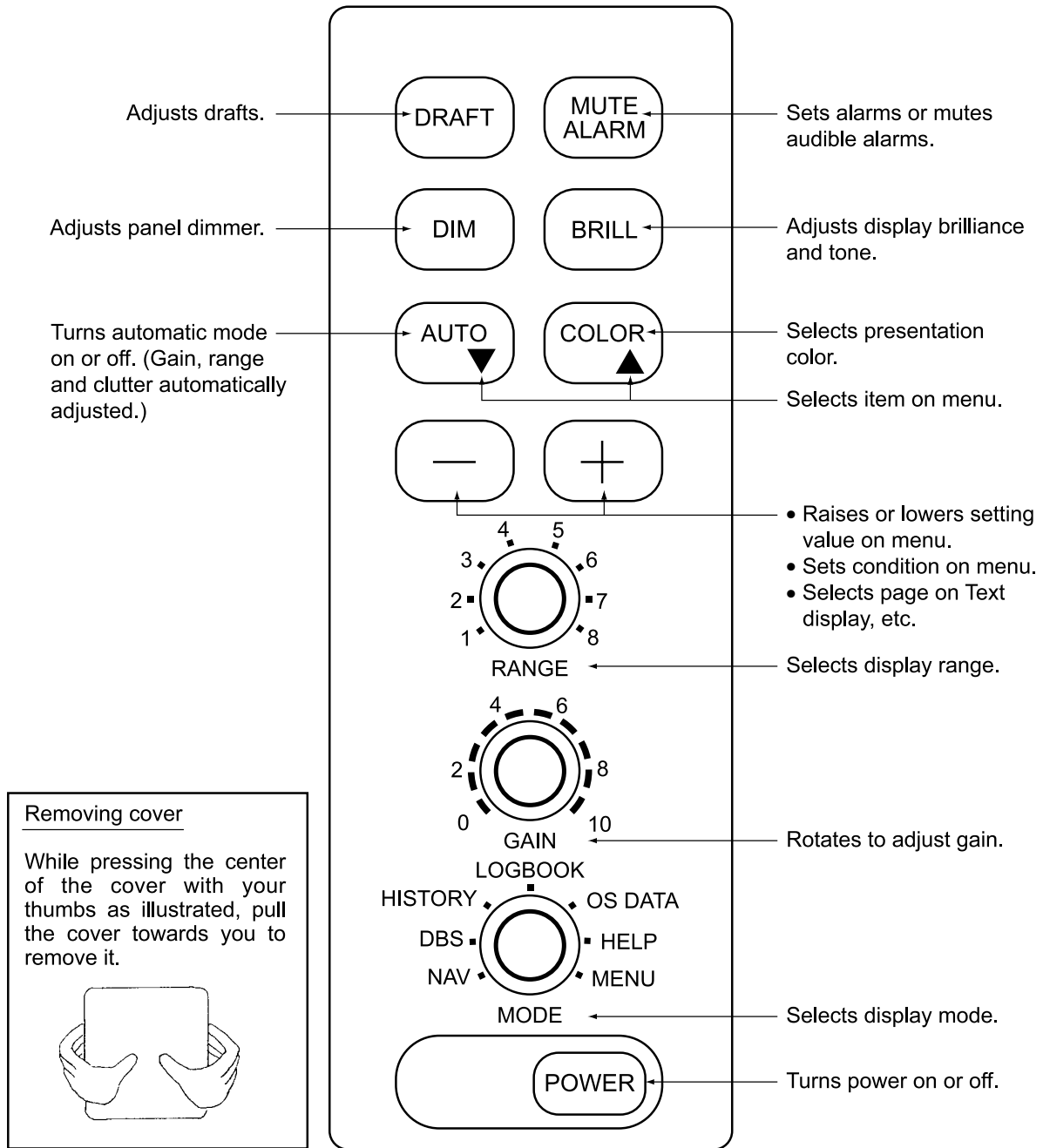

Removing cover

While pressing the center of the cover with your thumbs as illustrated, pull the cover towards you to remove it.

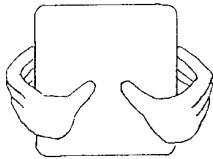

1.2 Indications, Markers

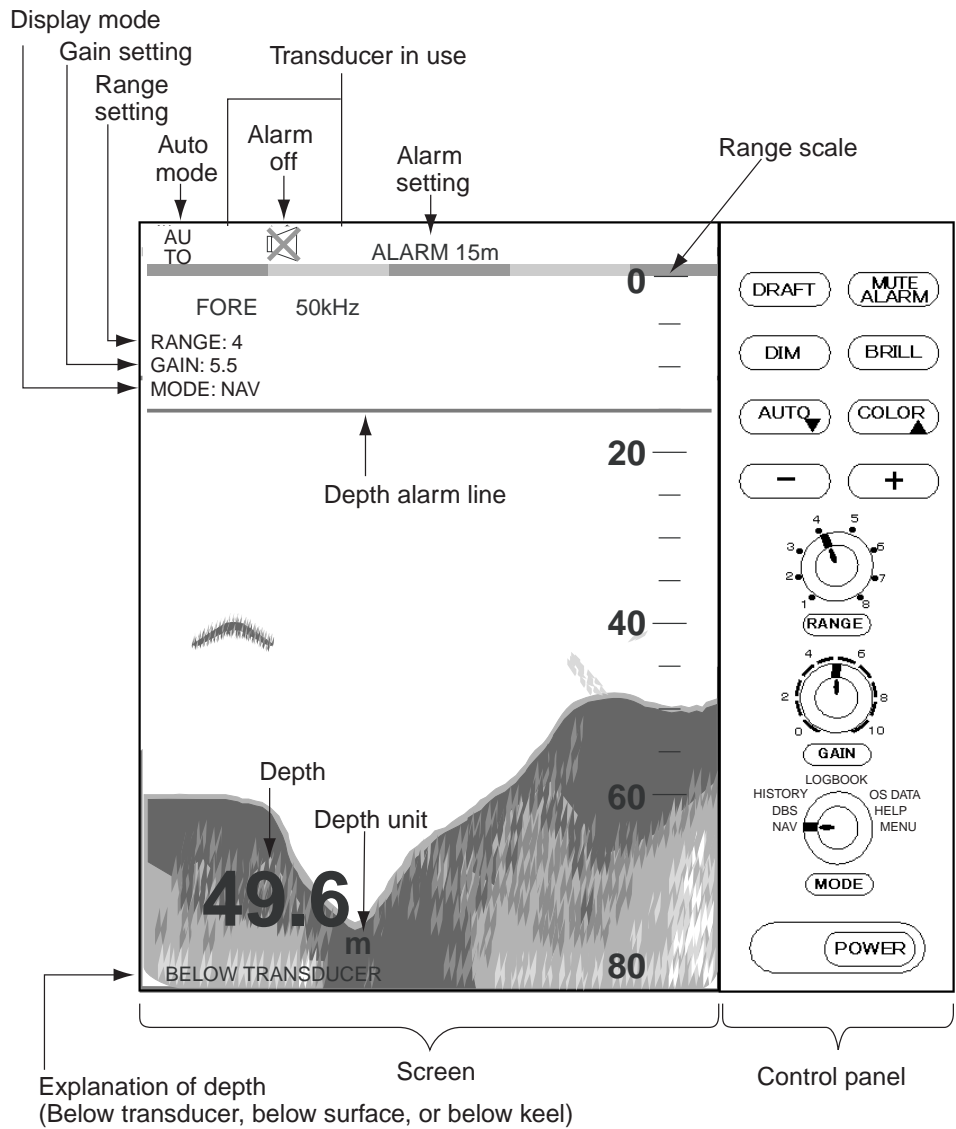

Ex. Single frequency display

The diagram shows a dual frequency display interface. It features two side-by-side depth profiles. The top of the screen displays **ALARM: 20m** and **DRAFT: 10.0m**. The left profile is labeled **AFT 50/FORE 200** and shows a depth of **49.6** **BELOW SURFACE**. The right profile shows a depth of **49.6** **m**. The vertical axis is labeled **Depth** and **Depth unit**, with markings at 0, 20, 40, 60, and 80.

When connecting two transducers via the optional distributor box MB-1200, the dual frequency display (as left) can be shown. To switch SINGLE and DUAL, see the Installation Manual.

1.3 Turning On/Off

1. **Turning on:** Press the POWER Switch. Self-test starts, showing the condition of the logic circuits. The program number is displayed.

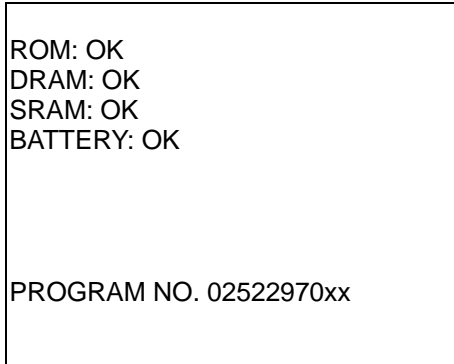

2. Select a mode with the MODE Selector. The **NAV** position of the selector is recommended for general use. Display color is amber by default but may be customized. The unit of measurement is meters. You can freely select another mode at any time.
3. **Turning off:** Press the POWER Switch again.

Wait at least 5 s before reapplying the power.

Note: When two transducers are installed, make sure which transducer is used.

Note: When lat/long data input error occurs, "EPFS" ERROR appears on the screen. (EPFS: Electronic Position-Fixing System such as GPS receiver)

1.4 Tone and Brilliance

1. Press the BRILL key. The tone and brilliance setting window appears.



2. Press the [+] or [-] key for desired tone (in reality, Contrast).
3. Press the [▲] or [▼] key for desired brilliance. Pressing the BRILL key also changes the brilliance from minimum to maximum and vice-versa.

Note: Tone or brilliance must be adjusted within 10 seconds after pressing the BRILL key. Otherwise the tone and brilliance window will be erased.

1.5 Panel Dimmer

1. Press the DIM key. The panel dimmer setting window appears.



2. Press the [+] or [-] key for desired illumination of the control panel. Pressing DIM key also changes the illumination level.

1.6 Display Mode

The Mode Selector choose the display mode among NAV, DBS (depth below surface), HISTORY, LOGBOOK, OS DATA, HELP, and MENU.

1.6.1 NAV mode

The depth from the transducer to the seabed (bottom clearance) is shown on the screen. Note “BELOW TRANSDUCER” appears at the bottom of the screen in this mode. If the transducer setting is DEPTH BELOW KEEL, “BELOW KEEL” appears at the bottom of the screen.

Default is,

Color: Amber

Range: Automatic range switching

Window: 15 minutes

Shallow depth alarm: 20 m

NOTE: These parameters can be customized to your preference and the last setting is used at a next switch-on. This is true on all other modes.

1.6.2 DBS mode

The Depth Below Surface mode provides a draft-adjusted depth reading and will be useful in referencing to the nautical chart. The draft should be adjusted by the DRAFT key according to the actual draft value. If you find any difficulty to check for the draft value, use the NAV mode.

When the DBS mode is selected, the message “Confirm and set ship’s draft to use DBS mode” appears. Confirm ship’s draft and set it by referring to section 1.12.

BELOW SURFACE appears at the bottom of the display and the draft value appears at the upper right-hand corner in the DBS mode.

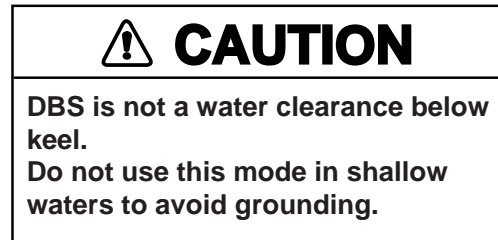

1.6.3 HISTORY mode

This mode provides a mix of Contour and Strata displays. The Contour display can be scrolled over the past 24 h while the right side Strata display (layers of different colors according to reverberation strengths) shows the latest sounding for 5 minutes.

Pressing the [+] or [-] key moves the Contour display forwards or backwards, respectively.

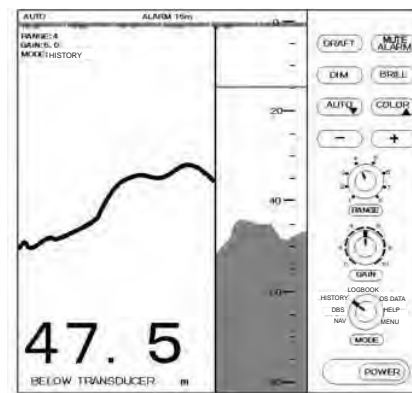

History of the bottom

If the range scale for both the Contour and Strata display must be the same. If they are not, the message “OUT OF RANGE” appears.

The update of the contour data may take max. one minute. Wait for one minute to display accurate contour if you change the range scale.

1.6.4 LOGBOOK mode

The LOGBOOK shows time, depth and own ship position in tabular form in a pop-up window. The logging is selected with the INTERVAL option on the menu among 5 s, 1 min and 2 min. (See section 2.6.)

There are 60 pages and the total memory capacity is 720 points. Page 60/60 is the latest data and 1/60 is the oldest data. Pressing [-] or [+] key changes the pages.

Note that if DEPTH BELOW KEEL is chosen, DBK also appears together with depth indication in the DEPTH column.

TIME	DEPTH	L/L	60/60
11:00:00	47.5	36° 55.012'N 135° 23.123'E	
11:01:00	47.5	36° 55.012'N 135° 23.123'E	
11:02:00	47.5	36° 55.012'N 135° 23.123'E	
11:03:00	47.5	36° 55.012'N 135° 23.123'E	
11:04:00	47.5	36° 55.014'N 135° 23.123'E	
11:05:00	47.5	36° 55.014'N 135° 23.123'E	

(Single display)

TIME	DEPTH	L/L	60/60
FORE 50kHz			
11:00:00	47.0	36° 55.012'N 135° 23.123'E	
11:01:00	46.2	36° 55.012'N 135° 23.123'E	
11:02:00	46.0	36° 55.012'N 135° 23.123'E	
11:03:00	45.8	36° 55.012'N 135° 23.123'E	
11:04:00	45.5	36° 55.014'N 135° 23.123'E	
AFT 200kHz			
11:00:00	45.1	36° 55.012'N 135° 23.123'E	
11:01:00	45.0	36° 55.012'N 135° 23.123'E	
11:02:00	44.9	36° 55.012'N 135° 23.123'E	
11:03:00	44.6	36° 55.012'N 135° 23.123'E	
11:04:00	44.5	36° 55.014'N 135° 23.123'E	

(Dual display)

* Depth below keel shown when transducer setting is DEPTH BELOW KEEL.

1.6.5 OS DATA mode

This display mode indicates own ship position, GPS-derived course and speed, and time and depth in digital form. You can read the data of your particular interest in large characters. The screen continues to display the sounding data in the background. Part of graphical indication is visible to the right of data slips.

TRUE(true course) or MAG (magnetic course) appears.

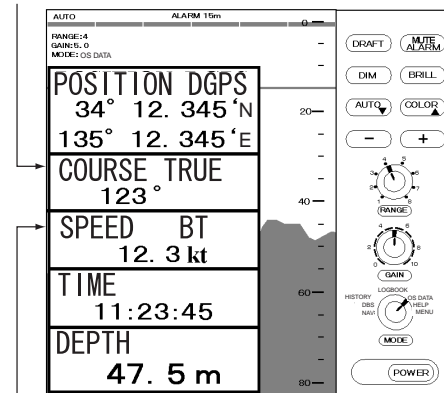

BT means Bottom track

There are two kinds of OS DATA displays: DATA 1 and DATA 2, as selected on the system menu. DATA 1 is shown in the figure above.

The DATA 2 display is as below.

TIME UTC	TIME UTC
11:23:45	11:23:45
DEPTH	DEPTH AFT FORE
17.2 m	17.2 m 17.2 m

(Single) (Dual)

Note: When lat/long data input error occurs in the DATA 1 mode, "EPFS" ERROR appears on the screen. (EPFS: Electronic Position-Fixing System such as GPS receiver)

Enlarging data of interest

You can enlarge one of the data indications as follows:

1. Press the [▲] or [▼] key to select the data you want to enlarge. Current section is circumscribed with the blue cursor. For example, select the depth cell.
2. Press the [+] key.

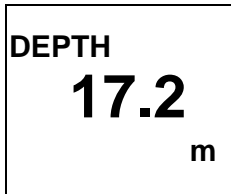

(Single display)

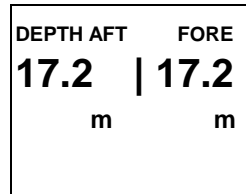

(Dual display)

3. To return to the original display, press the [-] key.

1.6.6 HELP display

This mode provides information about keys. Press desired key to obtain the corresponding information. The example below shows help information for MUTE ALARM.

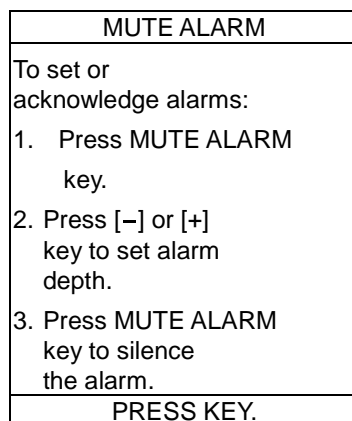
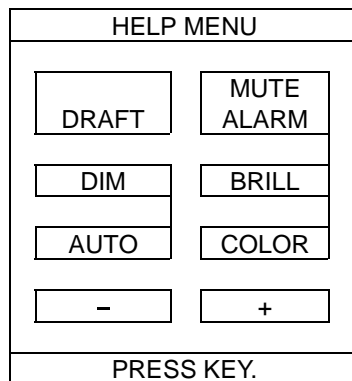

1.6.7 MENU display

The menu provides functions which normally do not require frequent adjustment. For details see Chapter 2.

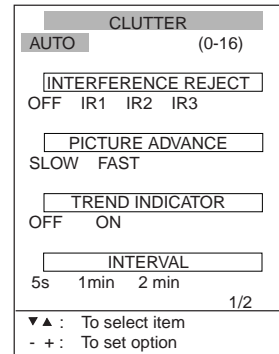

(Page 1/2)

Press the [▼] key when the cursor is on the "INTERVAL", and the following appears.

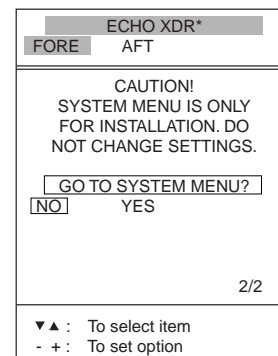

(Page 2/2)

*For Dual display, "HISTORY XDR" appears.

1.7 Range Scale

If the depth goes out of the correct display area, increase or decrease the range until the seabed appears near the center of the screen.

Adjust the Range Control, and current range selection is shown in the range display window.

RANGE	5 m
-------	-----

In the AUTO mode, the range scale is automatically adjusted. See section 1.9 for details.

1.8 Gain Control

The GAIN Control adjusts the sensitivity of the receiver. The AUTO mode provides automatic adjustment and you are normally not required to adjust it. Current setting is shown at the upper left-hand corner. Adjust the GAIN Control and the following window appears.

GAIN	5.5
------	-----

Adjust the GAIN Control so that a slight amount of noise remains on the screen. Generally, use a higher gain setting for greater depths and a lower setting for shallower waters. Adjusting range is between 0.0 and 10.0 in 0.5 steps.

1.9 Automatic Operation

The automatic function automatically selects the proper gain, range scale and clutter level according to depth. It works as follows:

- The range changes automatically to locate the bottom on the lower half of the screen. It jumps to one step shallower range when bottom echoes reach a halfway point of the full scale from top and to one step deeper range when they come to the lower edge of the scale.
- The gain is automatically adjusted to display the seabed in specified color.

- Clutter level (on the menu), which works as a threshold control to suppress overall noise, is automatically adjusted.

Note: The AUTO MODE is cancelled whenever the range or the gain is changed.

How to enable/disable automatic operation

1. Press the AUTO key. The AUTO mode window appears.

AUTO MODE	
OFF	ON
- / +: To set option	

2. Press the [+] key to select ON or the [-] key to select OFF.

1.10 Picture Colors

1. Press the COLOR key. The following window appears.

COLOR										
-	1	2	3	4	5	6	7	8	9	+

2. Press the [+] or [-] key to select a number, referring to the table below. (You can see the result of your selection on the display.)

	Background	Seabed	Others marks
1	Monochrome, 8 intensities		
2	Blue	Red infill	6 colors
3	Black	Red infill	6 colors
4	White	Red infill	6 colors
5	Blue	Yellow infill	6 colors
6	Black	Yellow infill	6 colors
7	White	Yellow infill	6 colors
8	Black	7 colors (Strata)	
9	White	7 colors (Strata)	

Monochrome (amber) is the default setting. The Strata display contains multiple colors depending on the reflectivity from underwater objects of the sounding pulses. Red is strongest, followed by brown, orange, yellow, blue, and light blue at the default setting.

1.11 Shallow Depth Alarm

The shallow depth alarm sounds when the seabed is shallower than the preset depth. The default in the NAV position is 20 m. You can adjust the alarm depth as below:

Activating/deactivating the alarm

1. Press the MUTE ALARM key to display the depth alarm setting window.

DEPTH ALARM
10 m
- / +: To set option

2. Press the [+] or [-] key to change setting depth. The setting is shown digitally at the top of the screen and graphically key the depth alarm line.

When the alarm is activated, the message "SHALLOW DEPTH ALARM" is displayed at the center on the screen.

Note: When the keel setting is 0.0 – 10.0 in the DBK mode, the shallow depth alarm setting will show a minus value. At this time, the alarm setting value indication shows "****" and the alarm function is disabled.

Acknowledging the alarm

You can silence the alarm by pressing the MUTE ALARM key. The message "SHALLOW DEPTH ALARM" moves to upper side of the screen.

1.12 Draft

It is necessary to set the draft to use the DBS display mode, which shows depth below surface.

(Single display)

1. Select DBS with the MODE control.
"Confirm and set ships draft to use DBS mode." appears.
2. Press the DRAFT key to display the draft setting window.

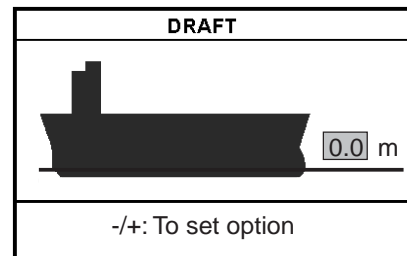

3. Press the [+] key to increase the setting depth and [-] key to decrease it. The setting depth is 0 to 30 m in steps of 0.1 m.
The above window disappears in 10 seconds.

The draft setting is displayed at the upper right corner and the range scale is shifted according to the draft setting.

(Dual display)

1. Select DBS with the MODE control.
"Confirm and set ships draft to use DBS mode." appears.
2. Press the [DRAFT] key to display the draft setting window for FORE.
3. Press the [+] key to increase the setting depth and [-] key to decrease it. The setting depth is 0 to 30 m in steps of 0.1 m. The above window disappears in 10 seconds.
4. Press the [DRAFT] key while the FORE setting window is shown, to display the draft setting window for AFT.
5. Press the [+] key to increase the setting depth and [-] key to decrease it. The setting depth is 0 to 30 m in steps of 0.1 m. The above window disappears in 10 seconds.

2 MENU OPERATION

2.1 Menu Overview

The menu has several functions for advanced operation.

1. Select MENU with the MODE Selector.

CLUTTER	
AUTO	(0-16)
INTERFERENCE REJECT OFF IR1 IR2 IR3	
PICTURE ADVANCE SLOW FAST	
TREND INDICATOR OFF ON	
INTERVAL 5s 1min 2 min	
1/2	
▼▲ : To select item	
- + : To set option	

(1/2)

ECHO XDR*	
FORE	AFT
CAUTION! SYSTEM MENU IS ONLY FOR INSTALLATION. DO NOT CHANGE SETTINGS.	
GO TO SYSTEM MENU?	
<input type="checkbox"/> NO	YES
2/2	
▼▲ : To select item	
- + : To set option	

(2/2, single mode)

*For the dual mode. "HISTORY XDR" appears.

2. Press the [▲] or [▼] key to select menu item. As you operate the [▲] or [▼] key, the selected item and its current setting appear in reverse video.
3. Press the [-] or [+] key to select option desired.
4. Set the MODE Selector in another position to close the menu.

2.2 Suppressing Low Level Noise

Light-blue dots may appear overall screen. This is mainly due to dirty water or noise. This noise can be suppressed by adjusting CLUTTER (in reality, Threshold of the amplifier).

When the automatic mode is on, the suppression setting is automatically adjusted. For manual override, do the following:

1. Select MENU with the MODE Selector.
2. Select CLUTTER by pressing the [▲] key.
3. Press the [-] or [+] key to select clutter rejection level desired. The higher the number the higher the degree of suppression. Note that weak echoes may not be displayed when the clutter circuit is on.

2.3 Suppressing Interference

Interference from other acoustic equipment operating nearby or other electronic equipment on your boat may show itself on the display.

To suppress interference, do the following:

1. Select MENU with the MODE Selector.
2. Select INTERFERENCE REJECT by pressing the [▲] or [▼] key.
3. Press the [-] or [+] key to select degree of suppression desired; OFF, IR1, IR2 or IR3. The higher the number the greater the degree of suppression.

Note that oversuppression will weaken the sensitivity.

2.4 Picture Advance

The picture advance speed determines how quickly the vertical scan lines run across the screen.

1. Select MENU with the MODE Selector.
2. Select PICTURE ADVANCE by pressing the [▲] or [▼] key.
3. Press the [+] or [-] key to select speed FAST or SLOW, respectively. The advance speed varies with the range scale and the viewing length of 15-16 minutes is available on all ranges (IMO requirements).

Range (m)	Display window (minute)
5, 10, 20	1.8/15 (FAST/SLOW)
40,100	8/15
200	16/20
400, 800	33/33

2.5 Trend

The future trend of the seabed depths can be predicted over a specified period of time (See page 13). The trend index is set with the item TREND INDICATOR and appears at the top left corner. The default setting is ON.

θ is inclination angle of bottom.

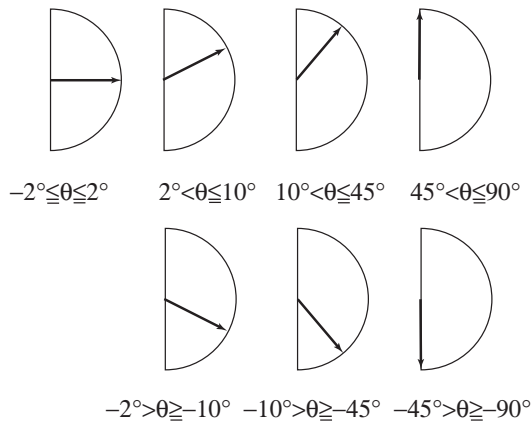

2.6 Interval

The interval for sampling data for the LOGBOOK and HISTORY modes can be set with INTERVAL, among 5 s, 1 min and 2 min. The default setting is 1 min.

TIME	DEPTH	L/L
11:00:00	47.5	36°55.012'N 135°23.123'E
11:01:00	47.5	36°55.012'N 135°23.123'E
11:02:00	47.5	36°55.013'N 135°23.123'E
11:03:00	47.5	36°55.013'N 135°23.123'E
11:04:00	47.5	36°55.014'N 135°23.123'E
11:05:00	47.5	36°55.014'N 135°23.123'E

In this example, the setting of INTERVAL is 1 minute. That is, the depth and lat/long data are displayed at 1 minute intervals.

2.7 Choosing the Transducer

Choose the transducer to use on all modes in the single display and HISTORY mode in the dual display.

1. Select MENU with the MODE Selector.
2. Select ECHO XDR (single display) or HISTORY XDR (dual display) by pressing the [▲] or [▼] key.

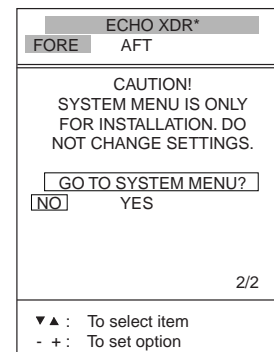

(Page 2/2)

*For Dual display, "HISTORY XDR" appears.

3. Press the [+] or [-] key to FORE or AFT.
4. Set the MODE Selector in another position to close the menu.

3 SYSTEM MENU

3.1 System Menu

The system menu should be set just after installation and is not always necessary to be adjusted. If you change any items of the system menu or even if you open the system menu, the sounding picture will be cleared. There are three menus: 1,2,and 3.

1. Select MENU with the MODE Selector.

CLUTTER	
AUTO	(0-16)
INTERFERENCE REJECT	
OFF	IR1 IR2 IR3
PICTURE ADVANCE	
SLOW	FAST
TREND INDICATOR	
OFF	ON
INTERVAL	
5s	1min 2 min
1/2	
▼▲ : To select item	
- + : To set option	

(1/2)

2. Press the [▼] key several times to display following window.

ECHO XDR*	
FORE	AFT
CAUTION!	
SYSTEM MENU IS ONLY	
FOR INSTALLATION. DO	
NOT CHANGE SETTINGS.	
GO TO SYSTEM MENU?	
NO	YES
2/2	
▼▲ : To select item	
- + : To set option	

(2/2, single display)

*For the dual display. "HISTORY XDR" appears.

3. Select YES by pressing the [+] key.

Confirmation message "ARE YOU SURE?" appears.

4. Press the [+] key again.

The system menu 1 appears.

5. With the cursor selecting MENU SELECT, operate the [-] or [+] key to select system menu desired; 1, 2 or 3.

SYSTEM MENU 1			
MENU SELECT	1	2	3
DEPTH UNIT	m	ft	fa
SPEED UNIT	kt	MPH	km/h
COURSE	TRUE	MAG	
BOTTOM LOST	OFF	ALARM	
GPS ALARM	OFF	ALARM	
INTERFACE	1:95	1:98	NMEA
ALARM SOUND	1	2	3
OS DATA	DATA1	DATA2	
LANGUAGE	English		
ALM BUZZER	OFF	ON	
▼▲ : To select item			
- + : To set option			
Select other mode to exit.			

↓ Press [+] at menu 1.

↑ Press [-] at menu 2.

SYSTEM MENU 2			
MENU SELECT	1	2	3
TIME ADJUST	INTERNAL	EXTERNAL	
DAY	1		
MONTH	JAN		
YEAR	2009	(~2100)	
HOUR	0	(0~23)	
MINUTE	0	(0~59)	
SECOND	0	(0~59)	
01 AUG 2009 00:00:00			
▼▲ : To select item			
- + : To set option			
Select other mode to exit.			

↓ Press [+] at menu 2.

↑ Press [-] at menu 3.

SYSTEM MENU 3			
MENU SELECT	1	2	3
BASIC RANGE1	5	(2~800)	
RANGE2	10	m	
RANGE3	20		
RANGE4	40		
RANGE5	100		
RANGE6	200		
RANGE7	400		
RANGE8	800		
TREND	1	min	

3.2 System Menu 1

DEPTH UNIT: Selects unit of depth measurement among meters, feet, or fathoms. Default setting is meters.

If "ft" or "fa" is selected, the depth unit is shown in red characters.

SPEED UNIT: Selects unit of speed measurement among knots, statute miles per hour, or kilometers per hour. Default setting is knots. Requires speed data, from external device.

COURSE: Selects heading reference; true or magnetic. Default setting is TRUE.

BOTTOM LOST: Turns on or off the bottom loss warning. "ALARM" sounds the alarm if the bottom signal is not detected. Default setting is "ALARM" (alarm is enabled).

GPS ALARM: The audible alarm may be released when the position-fixing mode is switched from DGPS to GPS and vice versa. Default setting is "ALARM" (alarm is enabled). Choose "OFF" if you do not need to be alerted with the audible alarm when the position-fixing mode is switched.

INTERFACE: Selects I/O signal format between the FE-700 and external equipment; IEC format "1:95" (1995 version) or "1:98" (1998 version), or NMEA format. Default setting is IEC "1:98". When selecting the "1:98", DPT has max. range in use (See page 24).

	Output	Input
IEC 61162-1	DPT DBT	RMA, RMC GLL, VTG ZDA, GGA
NMEA 0183	DBT (Ver.1.5) DBS (Ver.1.5) DBK (Ver. 1.5) DPT (Ver.2.0)	RMA, RMC GLL, VTG ZDA, GGA

ALARM SOUND: Selects audio alarm sound among 1, 2 or 3. Default setting is 1.

- 1: Continuous sound
- 2: Intermittent sound; 0.5 s on and 0.5 s off.
- 3: Intermittent sound; 1 s on and 1 s off.

OS DATA: Selects own ship data display mode; DATA 1 or DATA 2. DATA1 is the default setting. If a navigation device is not connected to the FE-700, select DATA 2.

LANGUAGE: Currently English is only available.

ALM BUZZER: When the alarm unit AU-12 is connected, select OFF. Then, the alarm off icon appears. If an alarm occurs, the AU-12 (not FE-700 display unit) sounds alarm.

3.3 System Menu 2

TIME ADJUST: Selects internal clock or external clock (UTC clock). Default setting is INTERNAL. For INTERNAL, set current day, month, year, hour, minute and second with [+], [-], [▼] or [▲] key. The setting clock appears and it counts upward.

SYSTEM MENU 2		
MENU SELECT	1	2 3
TIME ADJUST	INTERNAL	EXTERNAL
DAY	1	
MONTH	JAN	
YEAR	2001	(~2100)
HOUR	0	(0~23)
MINUTE	0	(0~59)
SECOND	0	(0~59)
01 AUG 2009 00:00:00		
▼▲: To select item		
- +: To set option		
Select other mode to exit.		

If EXTERNAL is selected, the screen changes as follows.

SYSTEM MENU 2		
MENU SELECT	1	2 3
TIME ADJUST	INTERNAL	EXTERNAL
TIME DIFFERENCE	AUTO	MANUAL
01 AUG 2009 00:00:00		
▼▲: To select item		
- +: To set option		
Select other mode to exit.		

TIME DIFFERENCE: Selects auto (UTC) or manual. Auto uses the time difference in ZDA (IEC 61162-1). In manual, it is necessary to enter the time difference in hours and minutes.

SYSTEM MENU 2	
MENU SELECT	1 2 3
TIME ADJUST	INTERNAL EXTERNAL
TIME DIFFERENCE	AUTO MANUAL
TIME DIFF HOUR	0 (0~13)
TIME DIFF MIN	0 (0~59)
TIME DIFF SIGN	- , +
01 AUG 2009 00:00:00	
▼▲: To select item	
- +: To set option	
Select other mode to exit.	

3.4 System Menu 3

RANGE 1- 8: Activates or deactivates specific range scales. Default ranges are 5, 10, 20, 40, 100, 200, 400, and 800 (meters). Setting area is 2 m to 800 m. The ranges 20 m and 200 m can not be changed. They are essential in this equipment.

Note: Ranges must be set in numerical order. For example, if range 1 is 5 m and range 3 is 20 m, range 2 should be between 6 and 19 m.

Trend: The trend index shows the probable bottom shape over a specified time within 1-10 minutes. The default setting is 1 minute. Set the Trend time with [+] or [-].

4 ECHO QUALITY SETTING

This chapter describes functions useful for improving echo sounding performance.

4.1 Demonstration Display

The demonstration program shows how the FE-700 works.

1. Turn off the equipment.
2. Press the POWER Switch while pressing any key. Release the key when the following EXTENSION MODE display appears.

EXTENSION MODE	
+ :	TRANSDUCER SETTING
- :	TEST
▲ :	CLEAR MEMORY
▼ :	DEMONSTRATION

3. Press the [▼] key to select DEMONSTRATION.

DEMONSTRATION	
<input type="checkbox"/> OFF <input type="checkbox"/> ON	
-/+ :	To set option
▼ :	EXTENSION MODE

4. Press the [+] key to select ON.
 5. Reset the power. "DEMO" appears above the depth indication on the echo sounder displays and at the top right-hand corner on the data and graphic displays.
- To return to the normal operation, select OFF at step 4 above. Restart the display unit.

4.2 Bottom Level

If the depth indication is unstable or the seabed cannot be displayed steadily notwithstanding the adjustment of the control panel, you may adjust the bottom echo level.

 CAUTION
If the level is set too low, the FE-700 may not be able to distinguish the bottom from fish echo and the depth indication may be unstable and if set to high the depth indication does not appear.

1. Press the MUTE ALARM key three times at the EXTENSION MODE. The start-up screen appears and shortly thereafter the BOTTOM LEVEL display appears.

BOTTOM LEVEL	
200kHz =	80 (20~200)
-+ :	200kHz*

- *: Either 200 kHz or 50 kHz is displayed depending on which frequency is used.
2. Set the level with the [+] or [-] key. The default level is 80.
 3. Press the POWER switch to finish the adjustment. Wait about 5 s and then turn on the power again.

Note: Do not switch transducer (frequency) at the EX-8 when setting the Bottom Level menu. If it is necessary to set bottom level for a different frequency, turn off the FE-700, switch transducer at EX-8 and then turn on the FE-700 again.

4.3 TVG Level

TVG (Time Varied Gain) compensates for propagation attenuation of the ultrasonic waves, reducing surface noise to provide a smooth display. The TVG lowers receiver sensitivity at the time of pulse emission and gradually increases it with time, thereby making objects of same reflectivity at different depths appear at the same intensity or colors on the display. The TVG working depth is down to approximately 150 m on the 200 kHz system and 350 m on the 50 kHz system. Outside this range the echoes from the seabed and fish schools are received in full level. There is no perceivable deterioration in performance.

1. Press the DRAFT key three times at the EXTENSION MODE display. The TVG SELECT window appears.

TVG SELECT
200kHz = 5 (0~9)
--+: 200kHz

2. Set the TVG curve with [+] or [-]. The default level is 5. Attenuation compensation curve is at 20LogR curve.
3. Press the POWER switch to finish the adjustment. Wait 5 s, and then turn it on again.

Note: Do not switch transducer (frequency) at the EX-8 when setting the TVG Level menu. If it is necessary to set TVG level for a different frequency, turn off the FE-700, switch transducer at EX-8 and then turn on the FE-700 again.

4.4 Echo Offset

The echo offset feature functions to compensate for too weak or too strong echo level. If the on-screen echo level appears to be too weak or too strong and the level cannot be adjusted satisfactorily with the GAIN control, do the following to adjust echo level.

1. Press the DIM key three times at the EXTENSION MODE display. The ECHO OFFSET screen appears.

ECHO OFFSET	
200kHz:	0 (-99~+99)
--+:	200kHz

2. Set the offset with [+] or [-]. The default value is 0.
3. Press the POWER switch to finish the adjustment. Wait about 5 s and then turn it on again.

5 OPERATION OF DIGITAL DEPTH INDICATOR FE-720 (OPTION)

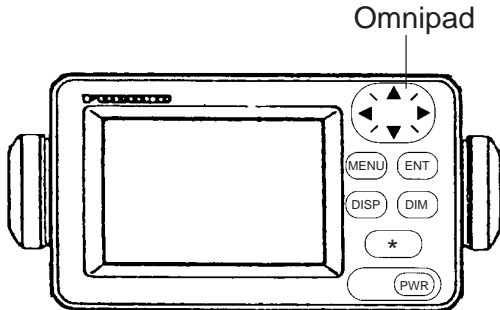

The Digital Depth Indicator FE-720 is an optional remote display. The panel illumination can be locally adjusted on the control panel or on the optional hand dimmer box.

5.1 Basic Operation

5.1.1 Turning on

Press the POWER key. The unit beeps and starts up with the last-used display. To turn off the unit, press the POWER key again.

5.1.2 Adjusting panel dimmer

1. Press the DIM key.
2. Press [◀] to increase the dimmer or [▶] to decrease it. The default is level 4.
3. Press the ENT key to finish the adjustment.

5.1.3 Adjusting Contrast

1. Press the [*] key. The following window appears.

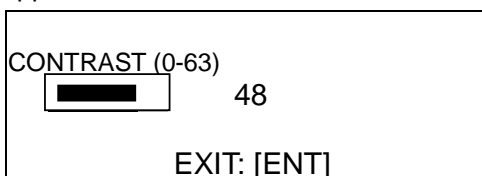

2. Press [◀] or [▶] until the required value is reached. The range of adjustment is from 0 (Min.) to 63 (Max.). The default is 48.
3. Press the ENT key to set.

Note: The contrast is automatically set to the default when you turn on the power.

5.1.4 DEPTH MODE

Depths are read either below transducer (keel) or below seaface irrespective of the main display. Select the mode as below:

1. Press the DISP key to select the wanted mode. The mode changes as below with each press.

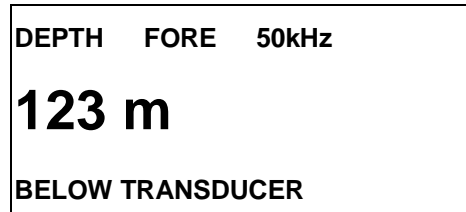

Depth below transducer

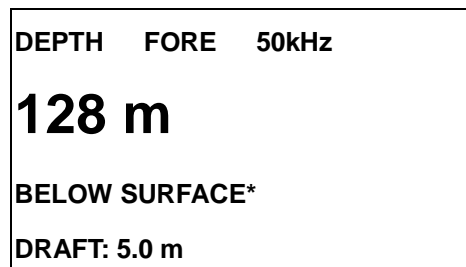

Depth below surface. Draft is determined on the main Display Unit FE-701.

*: If the keel distance is 0.1 to -10.0 (refer to page 8.) BELOW KEEL is displayed instead of the BELOW SURFACE.

5.2 Menu Operation

5.2.1 Dimmer control

The dimmer is controlled either with the DIM key, or the optional Dimmer Controller. The method of control must be selected on the menu.

1. Press the MENU key to display the main menu.

MENU	
DIM CONTROL	
	PANEL ONLY
ゲンゴ/LANG.	ENGLISH
UNITS	m
ALARM SET	ON
TEST	

2. Press [▲] or [▼] to select DIM CONTROL.
3. Press the ENT key. The following window appears.

MENU	
DIM CONTROL	
	PANEL ONLY
ゲンゴ/LANG.	PANEL ONLY
UNITS	EXT CONTROLLER
ALARM SET	EXT DISP
TEST	

4. Press [▲] or [▼] to select option desired.

PANEL ONLY: The illumination of the control panel is adjusted with the DIM key.

EXT CONTROLLER: Illumination of control panel is adjusted with the optional dimmer controller (hand dimmer box). The DIM key is inoperative.

EXT DISP: Not used.

5. Press the ENT key to set.
6. Press the MENU key to finish.

5.2.2 Selecting language

The language in use on the screen is either English or Japanese.

1. Press the MENU key to display main menu.
2. Press [▲] or [▼] to select the ゲンゴ/LANG.
3. Press the ENT key. The following window appears.

ENGLISH
ワブン

4. Press [▲] or [▼] to select appropriate option. The default is English.
5. Press the ENT key to set.
6. Press the MENU key to finish.

5.2.3 Selecting the unit of depth measurement

The unit of depth measurement is separately selected from the Main Display FE-701.

1. Press the MENU key to display main menu.
2. Press [▲] or [▼] to select the UNITS.
3. Press the ENT key. The following window appears.

m
ft
fa

4. Press [▲] or [▼] to select unit. The default is meter (m).
5. Press the ENT key to set.
6. Press the MENU key to finish.

5.2.4 Alarm

You can set turn alarm on or off. In the ON mode, if the main display unit activates the alarm, the FE-720 also.

1. Press the MENU key to display main menu.
2. Press [▲] or [▼] to select ALARM.
3. Press the ENT key. The following window appears.

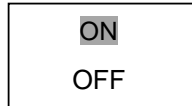

4. Press [▲] or [▼] to select appropriate option. The default is ON.
5. Press the ENT key to set.
6. Press the MENU key to finish.

If the alarm sounds, press any key to silence it.

5.3 Diagnosis

The diagnostic test checks ROM, RAM, keys and LCD of the FE-720.

1. Press the MENU key to display main menu.
2. Press [▲] or [▼] to select TEST.
3. Press the ENT key. The following window appears.

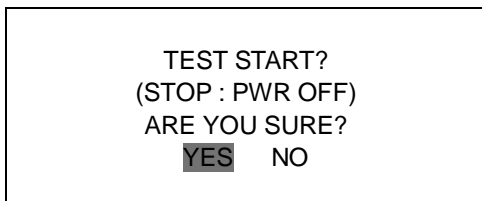

4. With YES selected, press the ENT key to start the test. The equipment tests the ROM and RAM, displaying the results as OK or NG (No Good). If NG appears, contact your dealer for advice.

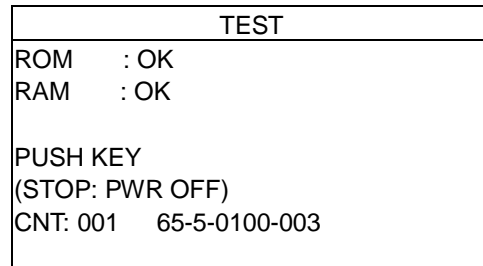

5. After "PUSH KEY" is displayed, press each key one by one. The name of the key pressed momentarily appears if the key is functioning properly.

The display shows the following message to inform you that the program is now going to check the LCD.

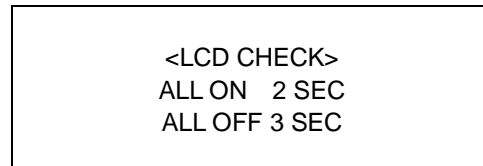

The whole display brightens for 2 seconds then turns off for 3 seconds. Test repeats. CNT, which is number of times the test has been consecutively executed, is counted up.

6. To stop the test, turn off the power.

5.4 Factory Setting

You can restore default settings to start operation anew. Press the POWER switch while pressing [▲]. The message "RESET BACKUP DATA!" appears. After a while, all default settings are restored and the depth indication appears.

6 MAINTENANCE, TROUBLESHOOTING

WARNING

Do not open the cover.

There are no user-serviceable parts inside. Refer any repair work to a qualified technician.

NOTICE

Do not apply paint, anti-corrosive sealant or contact spray to coating or plastic parts of the equipment.

Those items contain organic solvents that can damage coating and plastic parts, especially plastic connectors.

6.1 Checking

Regular maintenance is essential for good performance. Checking the items listed in the table below on a regular basis will keep the equipment in good shape for years to come.

Item	Action
Cable run	If conductors are exposed, replace cable.
Power cable, transducer cable plug	If loosened, tighten.
Display unit ground	If corroded, clean.
Ship's mains voltage	If out of rating, correct problem.

6.2 Cleaning the Display Unit

Dust or dirt on the display unit should be removed with a soft cloth. If desired a water-moistened cloth may be used. Do not use chemical cleaners; they can remove paint and markings.

6.3 Transducer Maintenance

Marine life on the transducer face will result in a gradual decrease in sensitivity. Check the transducer face for cleanliness each time the ship is dry-docked. Carefully remove any marine life with a piece of wood or fine-grade sandpaper.

6.4 Replacing the Fuse, Battery

If a fuse blows, find the cause before replacing it. Use only designated fuses. Using the wrong fuse will damage the unit and void the warranty.

Three types of fuses are used in the distribution box FE-702.

For Display Unit : 3 A x 1 pc (24 VDC)
 For Digital Depth Indicator: 0.5 A x 2 pcs
 For AC input: 1 A x 2 pcs

The Digital Depth Indicator FE-720 uses one fuse of 1 A, which is inserted in the positive line of interconnection cable.

A battery installed on a circuit board inside the display unit preserves data when the power is turned off. The life of the battery is about three years. When the battery voltage is low, "battery" NG appears at the self-test. When this happens, contact your dealer to request replacement of the battery.

	TYPE	Code Number
Lithium Battery	CR2450-F2 ST2	000-133-495

6.5 Troubleshooting

The table below provides simple troubleshooting procedures which you may follow to restore normal operation. If you cannot restore normal operation, contact your dealer.

SYMPTOM	PROBABLE CAUSES	REMEDY
No picture; no reading measure	Low power supply	Check the supply voltage.
	Fuse blown	Replace the fuse.
	Power cable damaged	Check the cable and repair.
No echo sounding picture	Transducer cable damaged	Repair the cable.
	Transducer cable connection loosened	Tighten the connections.
	Transmitter not working	Make sure the maximum output power is selected. (See section 3.2 System Menu 1.)
Irregular display	Low sensitivity	Increase the Gain by turning the GAIN control clockwise.
	Low reflectivity from seabed	Suspect muddy seabed.
	Marine life on transducer	Remove marine life from the transducer when dry docked.
Loss of seabed display	Out of range	Check the range scale setting.
	Air bubbles caused by going astern or running over other ship wakes	This is normal, it is not a sign of equipment trouble.
Heavy noise	Wrong installation place of transducer	Find cause of noise. Relocate the transducer if noise persists.
	Other echo sounders nearby	If more than one echo sounder is working on the ship, there is no ideal measure to cure the problem.
Surface noise	Aeration in near surface area	Not an equipment problem.
	Rough weather	Not an equipment problem.

6.6 Diagnostic Test

The diagnostic test checks the ROM, RAM, color bar and keyboard for proper operation.

1. Turn on the power while pressing any key. Release the keys when the following display appears.

EXTENSION MODE	
+ :	TRANSDUCER SETTING
- :	TEST
▲ :	CLEAR MEMORY
▼ :	DEMONSTRATION

SELECT MODE	
-------------	--

2. Press the [-] key.

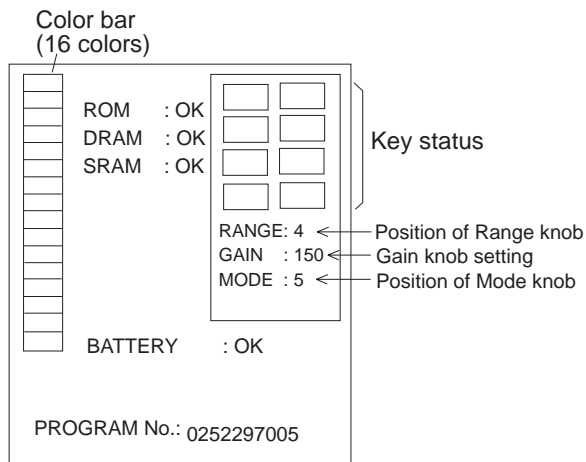

3. The ROM, DRAM, SRAM and internal battery are checked and the results are displayed as OK or NG (No Good). If NG appears, contact your dealer for advice.
4. Press and release each key (except the POWER switch) one by one. If the key is normal, its on-screen location lights in black while the key is pressed.
5. Operate the controls. The RANGE and MODE control setting indications should be the same as actual control settings. The GAIN control setting indication should be between 0 and more than 230.
6. Press the POWER SWITCH to finish. Turn on the power again to resume operation.

6.7 Test Pattern

The test pattern is used to check color performance.

1. Turn on the POWER SWITCH while pressing any key.
2. Press the BRILL key three times. Press the BRILL key again to change the test pattern as below.

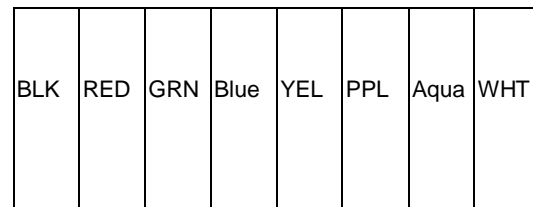
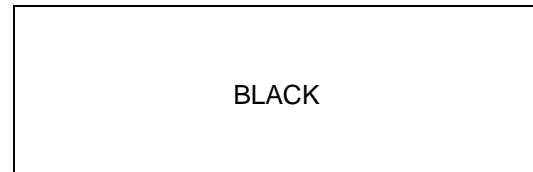

3. Press the BRILL key again to return to the EXTENSION MODE menu.

6.8 Clearing the Memory

All menu settings can be cleared to start afresh. All default menu settings are restored when the memory is cleared. For your reference all default settings are shown in the menu tree at the end of this manual.

1. Turn on the power while pressing any key. Release the keys when the EXTENSION MODE menu appears.
2. Press the [▲] key. The following window appears.

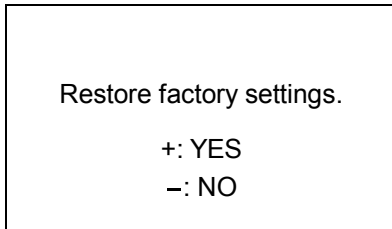

3. Press the [+] key to clear the memory. The following window appears.

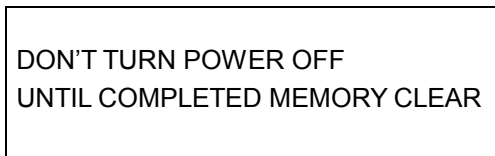

Then the following display appears after the memory is cleared.

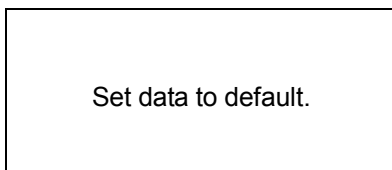

4. After data is cleared, the EXTENSION MODE menu appears.

Note: The setting for the items LANGUAGE and TRANSDUCER in the system menu is not disturbed when the memory is cleared.

7 MENU TREE

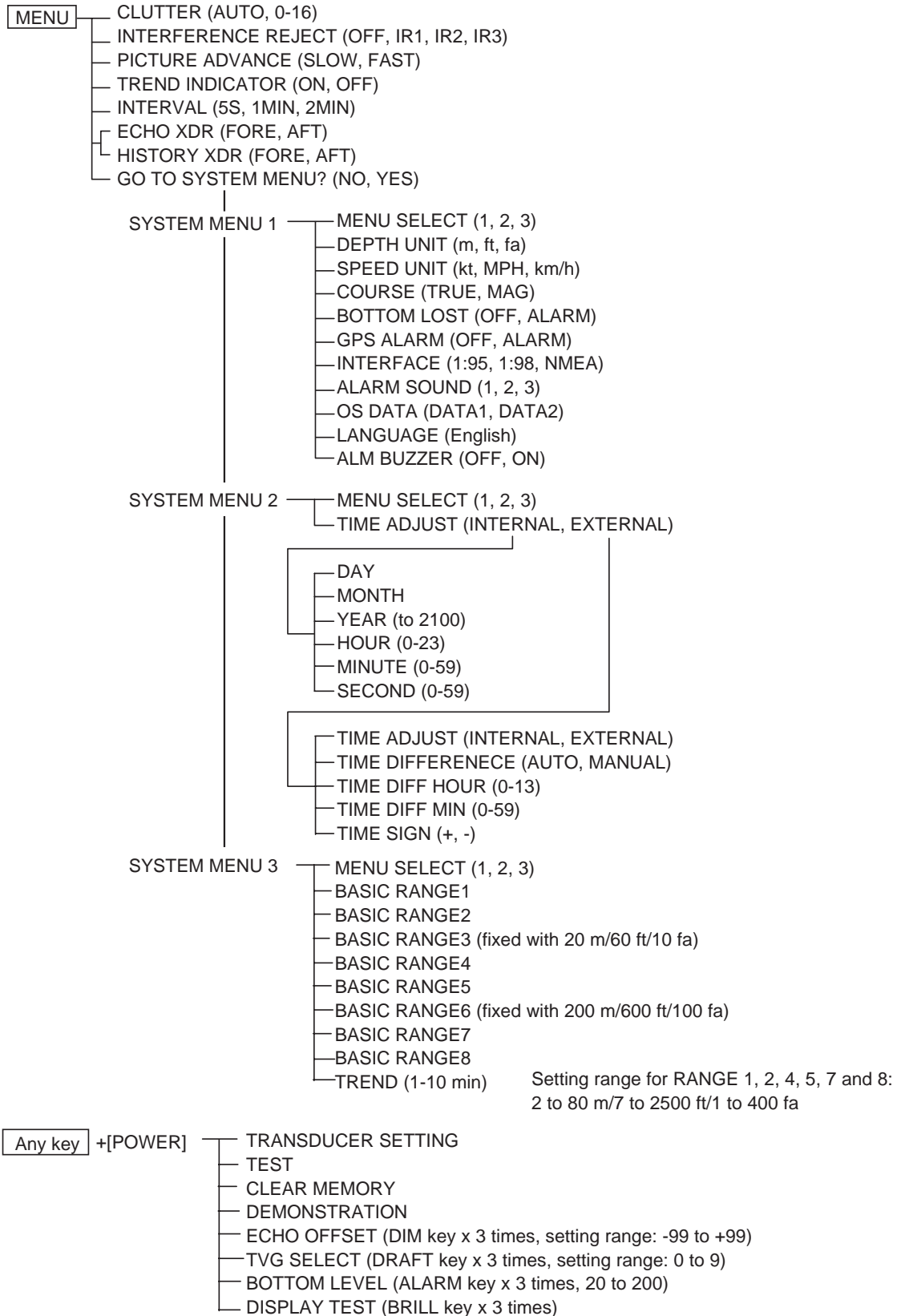

8 DIGITAL INTERFACE (IEC 61162-1 EDITION 2)

1. I/O Sentences

Input sentences of channel 1 (NAV IN)

RMA, RMC, GLL, GGA, VTG, ZDA

Output sentences of channel 2 (NAV OUT)

DBT, DPT, DBS (NMEA 0183), DBK (NMEA 0183)

Transmission interval

1 s for any sentence

Data transmission

Data is transmitted in serial asynchronous form in accordance with the standard referenced in 2.1 of IEC 61162-1. The first bit is a start bit and is followed by data bits, least-significant-bit as illustrated below.

The following parameters are used:

Baud rate: 4800

Data bits: 8 (D7 = 0), parity none

Stop bits: 1

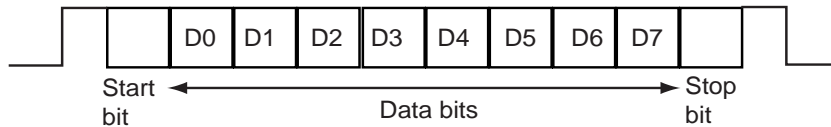

2. Schematic Diagrams

NAV IN port (listener)

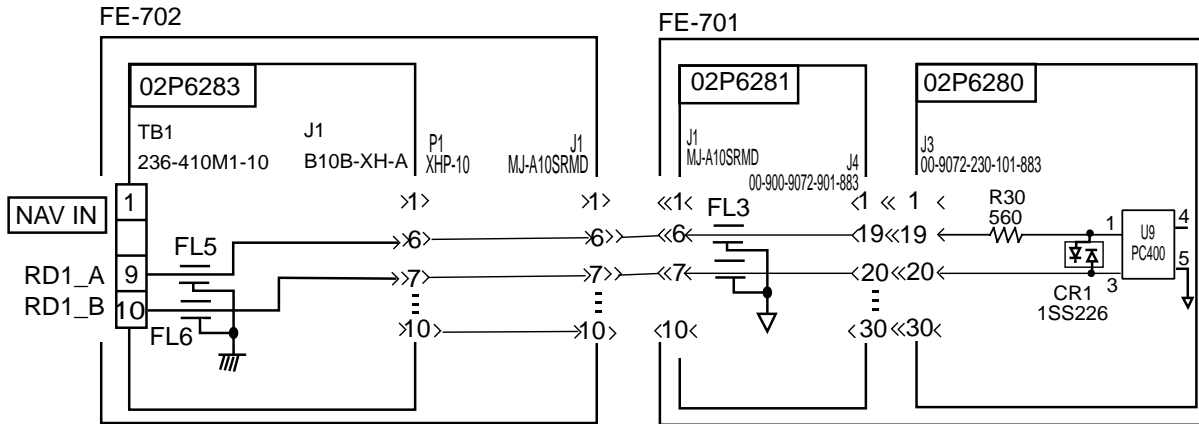

Load requirements as listener

Isolation: Optocoupler

Input Impedance: 560 ohms

Max. Voltage: $\pm 15V$

NAV OUT ports

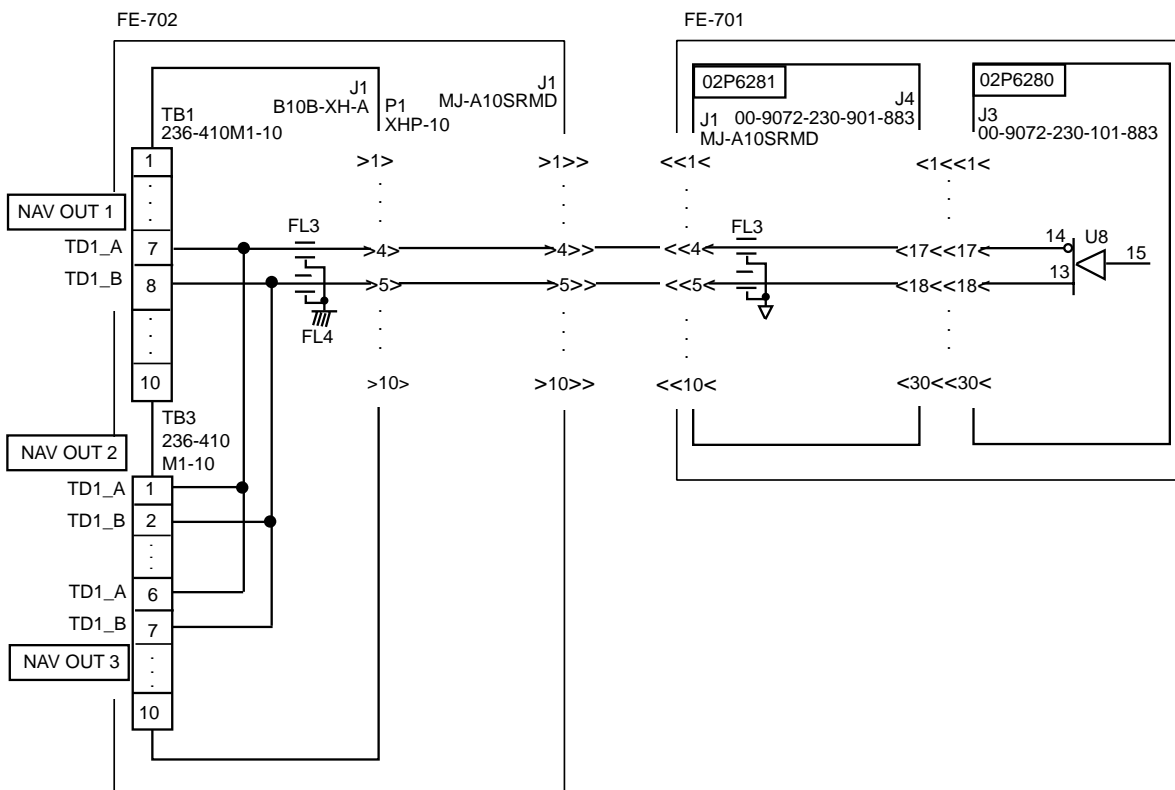

Total output for NAV OUT ports: Max. 20 mA

3. Sentence Description

DPT - Depth

\$--DPT,x,x,x,x,x,x*hh<CR><LF>

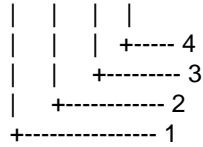

1. Water depth relative to transducer, in meters
2. Offset from transducer, in meters(see notes 1 and 2)
3. Maximum range scale in use
4. Checksum

NOTE1 "positive"=distance from transducer to water-line.
"- "=distance from transducer to keel.

NOTE2 For IEC applications the offset should always be applied so as to provide depth relative to the keel.

DBK – Depth below keel

\$--DBK,x,x,f,x,x,M,x,x,F*<CR><LF>

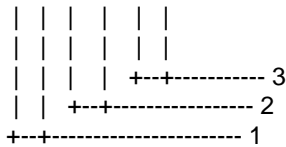

1. Water depth, feet
2. Water depth, m
3. Water depth, fathoms

DBS – Depth below surface

\$--DBS,x,x,f,x,x,M,x,x,F*<CR><LF>

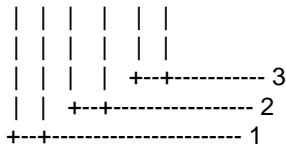

1. Water depth, feet
2. Water depth, m
3. Water depth, fathoms

DBT – Depth below transducer

\$--DBT,x,x,f,x,x,M,x,x,F*hh<CR><LF>

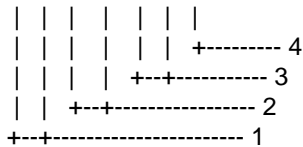

1. Water depth, feet
2. Water depth, m
3. Water depth, fathoms
4. Checksum

GLL - Geographic position - latitude/longitude

\$--GLL,III.III,a,yyyyy.yyy,a,hhmmss.ss,A,a*hh<CR><LF>

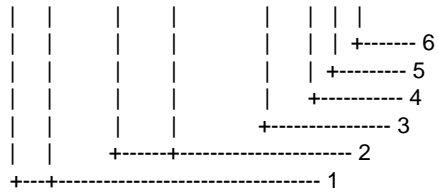

1. Latitude, N/S
2. Longitude, E/W
3. UTC of position
4. Status: A=data valid, V=data invalid
5. Mode indicator(see note)
6. Checksum

NOTE Positioning system Mode indicator:

- A = Autonomous
- D = Differential
- E = Estimated (dead reckoning)
- M = Manual input
- S = Simulator
- N = Data not valid

The Mode indicator field supplements the Status field. The Status field shall be set to V=invalid for all values of Operating Mode except for A=Autonomous and D=Differential. The positioning system Mode indicator and Status field shall not be null fields.

GGA - Global positioning system (GPS) fix data

\$--GGA,hhmmss.ss,llll.lll,a,yyyyy.yyy,a,x,xx,x.x,x.x,M,x.x,M,x.x,xxxx*hh<CR><LF>

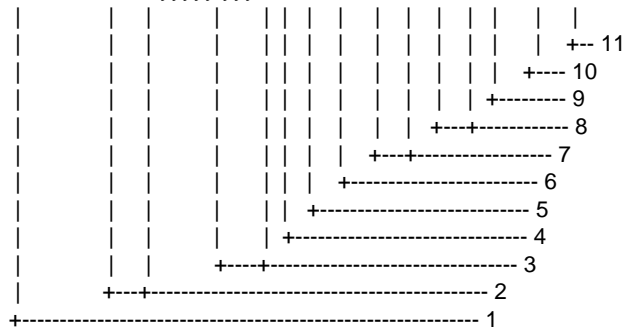

1. UTC of position
2. Latitude, N/S
3. Longitude, E/W
4. GPS quality indicator (see note)
5. Number of satellite in use,00-12, may be different from the number in view
6. Horizontal dilution of precision
7. Antenna altitude above/below mean sealevel, m
8. Geoidal separation, m
9. Age of differential GPS data
10. Differential reference station ID, 0000-1023
11. Checksum

NOTE

- 0 = fix not available or invalid
 - 1 = GPS SPS mode, fix valid
 - 2 = differential GPS, SPS mode, fix valid
 - 3 = GPS PPS mode, fix valid
 - 4 = Real Time Kinetic. Satellite system used in RTK mode with fixed integers
 - 5 = Float RTK. Satellite system used in RTK mode with floating fingers
 - 6 = Estimated (dead reckoning) mode
 - 7 = Manual input mode
 - 8 = Simulator mode
- The GPS quality indicator shall not be a null field.

RMA - Recommended minimum specific LORAN-C data

\$--RMA,A,IIII.III,a,yyyyy.yy,a,x.x,x.x,x.x,x.x,x.x,x.x,a*hh<CR><LF>

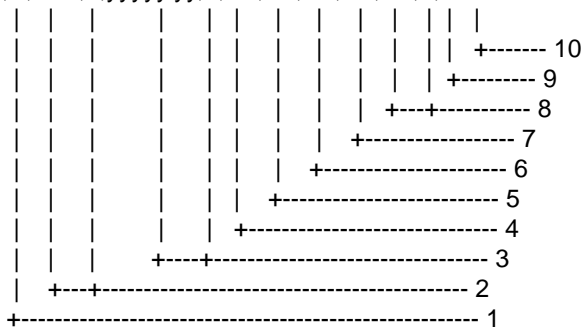

1. Status: A=data valid, V=blink, cycle or SNR warning
2. Latitude, degrees N/S
3. Longitude, degrees E/W
4. Time difference A, microseconds
5. Time difference B, microseconds
6. Speed over ground, knots
7. Course over ground, degrees true
8. Magnetic variation(see note 1),degree E/W
9. Mode indicator(see note 2)
10. Checksum

NOTE 1 - Easterly variation(E) subtracts from true course
Westerly variation(W) adds to true course

NOTE 2 Positioning system Mode indicator:

- A = Autonomous
- D = Differential
- E = Estimated (dead reckoning)
- M = Manual input
- S = Simulator
- N = Data not valid

The Mode indicator field supplements the Status field. The Status field shall be set to V=invalid for all values of Operating Mode except for A=Autonomous and D=Differential. The positioning system Mode indicator and Status field shall not be null fields.

RMC - Recommended specific GPS/TRANSIT data

\$--RMC,hhmmss.ss,A,III.III,a,yyyyy.yyy,a,x.x,x.x,xxxxxx,x.x,a*hh<CR><LF>

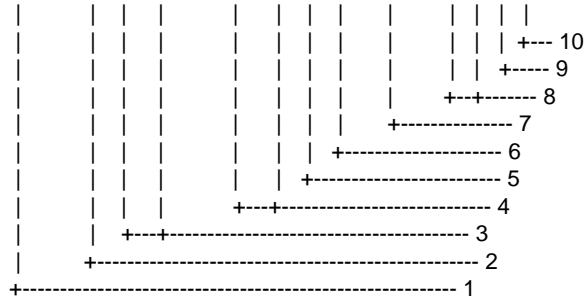

1. UTC of position fix
2. Status: A=data valid, V=navigation receiver warning
3. Latitude, N/S
4. Longitude, E/W
5. Speed over ground, knots
6. Course over ground, degrees true
7. Date: dd/mm/yy
8. magnetic variation, degrees E/W
9. Mode indicator(see note)
10. Checksum

NOTE Positioning system Mode indicator:

- A = Autonomous
- D = Differential
- E = Estimated (dead reckoning)
- M = Manual input
- S = Simulator
- N = Data not valid

The Mode indicator field supplements the Status field. The Status field shall be set to V=invalid for all values of Operating Mode except for A=Autonomous and D=Differential. The positioning system Mode indicator and Status field shall not be null fields.

VTG- Course over ground and ground speed

\$--VTG,x.x,T,x.x,M,x.x,N,x.x,K,a*hh<CR><LF>

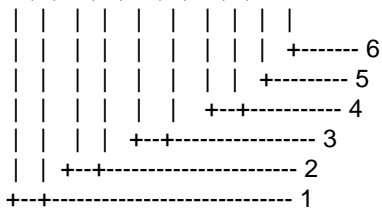

1. Course over ground, degrees true
2. Course over ground, degrees magnetic
3. Speed over ground, knots
4. Speed over ground, km/h
5. Mode indicator(see note)
6. Checksum

NOTE Positioning system Mode indicator:

- A = Autonomous
- D = Differential
- E = Estimated (dead reckoning)
- M = Manual input
- S = Simulator
- N = Data not valid

The positioning system Mode indicator field shall not be a null field.

ZDA - Time and date

\$--ZDA,hhmmss.ss,xx,xx,xxxx,xx,xx*hh<CR><LF>

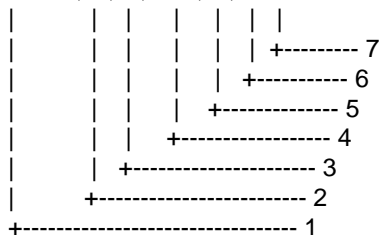

1. UTC
2. Day, 01 to 31(UTC)
3. Month, 01 to 12(UTC)
4. Year(UTC)
5. Local zone hours, 00h to +-13h
6. Local zone minutes, 00 to +59
as local hours
7. Checksum

9 PARTS LOCATION, PARTS LIST

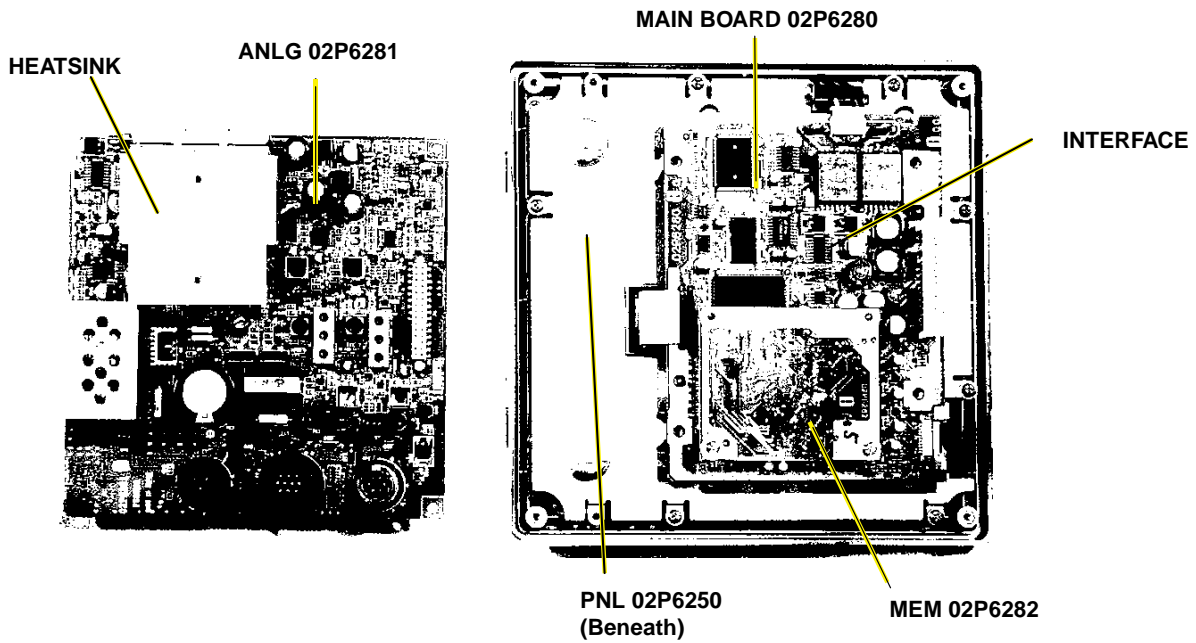

MAIN DISPLAY UNIT FE-701, INSIDE VIEW
(SHIELD COVER REMOVED)

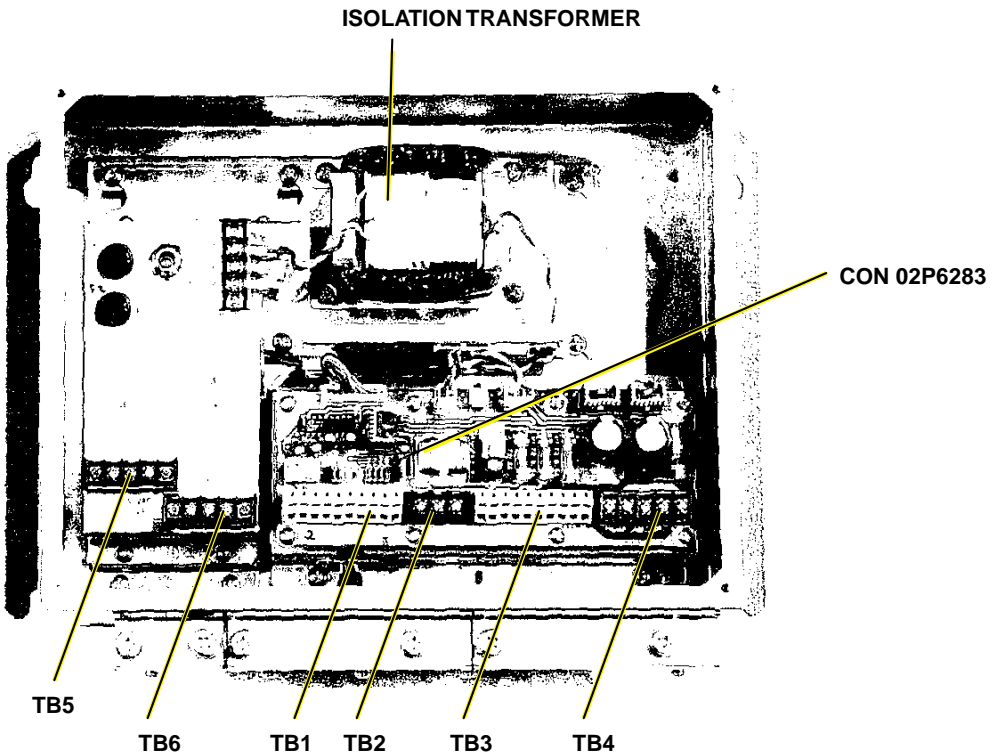

DISTRIBUTION BOX FE-702,
INSIDE VIEW

FURUNO

ELECTRICAL PARTS LIST

Jan-99

Model	FE-700		
Unit	DISPLAY UNIT FE-701 DISTRIBUTION BOX FE-702		
Ref.Dwg.			Page
Blk.No.			

SYMBOL	TYPE	CODE No.	REMARKS	SHIPPABLE ASSEMBLY
PRINTED CIRCUIT BOARD				
	02P6281,ANLG	001-229-240	FE-701	O
	02P6282,MEM	001-229-220	FE-701	O
	02P6283,CONE	001-229-030	FE-702	O
	02P6280,MAIN	001-229-190	FE-701	
PANEL ASSEMBLY				
	FE-701	001-229-370	w/PAL 02P6250	O
COVER				
	FE-701	001-229-340		O
POWER ASSEMBLY				
	FE-702	001-228-980		O
TRANSFORMER				
T1	02S1256-0	000-142-779	FE-702	
SWITCH				
S1	M-2032L/B	000-474-351	FE-702	
FILTER				
FL1	ZCB2203-11	000-128-847	FE-702	
FUSE HOLDER				
FX1	FH043A	000-138-885	FE-702	
FX2	FH043A	000-138-885	FE-702	
TERMINAL BOARD				
TB6	ML250S1AXF-3P	00-142-535	FE-702	
TB7	ML250S1AXF-3P	00-142-535	FE-702	
JACK				
J1	MJ-A10SRMD	000-126-663		
FUSE				
F1	FGMB 1A 250V	000-142-771		
F2	FGMB 1A 250V	000-142-771		



Pub NO. DOC-967

Declaration of Conformity



0735

We **FURUNO ELECTRIC CO., LTD.**

(Manufacturer)

9-52 Ashihara-Cho, Nishinomiya City, 662-8580, Hyogo, Japan

(Address)

declare under our sole responsibility that the product

Navigational echo sounder type FE-700 consisting of Display unit FE-701, Distribution box FE-702, Matching box MB-502 (50 kHz) or MB-504 (200 kHz), Transducer 50B-6B (50 kHz) or 200B-8B (200 kHz), Junction box JIS F8821-1 and optional Transducer switch box EX-8, Digital depth indicator FE-720 and Terminal box DS-802

(Model name, serial number)

to which this declaration relates conforms to the following standard(s) or normative document(s)

IMO Resolution A.224(VII)

IMO Resolution MSC.74(69) annex 4

IMO Resolution A.694(17)

EN ISO 9875: 1997 (ISO 9875 2nd edition: 1996-08-01)

ISO 9875 3rd edition: 2000-11-01

EN 60945: 1997-01 (IEC 60945 3rd edition: 1996-11)

IEC 60945 4th edition: 2002-08

EN 61162-1: 2001 (IEC 61162-1 2nd edition: 2000-07)

(title and/or number and date of issue of the standard(s) or other normative document(s))

For assessment, see

- EC type examination (Module B) certificate BSH/4612/4060212/06 and USCG Approval No. 165.107/WC0735/4060212 of 07 February 2006 issued by Federal Maritime and Hydrographic Agency, The Federal Republic of Germany
- EC quality system (Module D) certificate BSH/4613/022202/0339/06 of 04 July 2006 issued by Federal Maritime and Hydrographic Agency, The Federal Republic of Germany
- Test report FLI 12-99-036 of November 2, 1999 and FLI 12-05-051 of 11 November 2005 prepared by Furuno Labotech International Co., Ltd., Japan

This declaration is issued according to the provisions of European Council Directive 96/98/EC on marine equipment modified by Commission Directive 2002/75/EC.

On behalf of Furuno Electric Co., Ltd.

Nishinomiya City, Japan
September 3, 2007

(Place and date of issue)

Hiroaki Komatsu
Manager,
International Rules and Regulations

(name and signature or equivalent marking of authorized person)