

FA-50

CLASS B AIS TRANSPONDER



The FA-50 offers accurate information for collision avoidance



FA-50 CLASS B AIS TRANSPONDER

with GPS antenna
GPA-0175

FURUNO's FA-50 class-B AIS transponder receives navigation data from AIS-equipped vessels nearby that can be utilized to aid in safe navigation. Also, the FA-50 transmits own ship's information to the vessels around, which also aids in collision avoidance.

AIS utilizes a VHF data link to exchange own ship information with other AIS-equipped vessels around. The FA-50 incorporates the received AIS information into radar, a chart plotter and other graphic display options such as a PC to improve situational awareness. AIS targets on the screens are

shown with SOG/COG vector, which greatly assists you in grasping the surrounding situation even in the midst of congested waterways. Also, Closest Point of Approach (CPA) and Time to Closest Point of Approach (TCPA) can be computed and displayed on the radar/chart plotter screens.

The FA-50 feeds AIS data to the NavNet 3D and vx2 series or a PC with FURUNO's AIS Viewer software interfaced through Ethernet. The FA-50 can also be interfaced with a FURUNO chart plotter and radar via NMEA 0183 format to supplement information to the onboard navigation system.

exchange that can be utilized

What is AIS?

The Automatic Identification System (AIS) improves the safety level of boating by exchanging information about the status of your ship with other AIS-equipped craft nearby. The system utilizes VHF broadcasts to handle information about the surrounding area, such as other craft and buoys and other aids-to-navigation.

The AIS data includes target position, course and speed over ground, allowing you to foresee the course changes of particular targets. AIS targets are constantly visible even when they are shrouded in fog, in darkness, behind headlands, river bends or other obstructions.

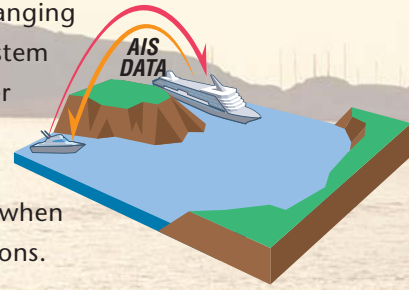

Comparison between Class-A and Class-B

	Class-A	Class-B
Vessel applied	SOLAS vessel	Non-SOLAS vessel
Access scheme	SOTDMA (Self Organized Time Division Multiple Access) Reserves a particular time slot and negotiates the use of that time slot with other Class-A vessels within radio range.	CSTDMA (Carrier Sensing Time Division Multiple Access) Uses any time slot as and when it is available. If no slot is available, Class-B AIS tries to access to the slot again after a pre-set time.
Frequency Range	156.025 - 162.025 MHz	156.025 - 162.025 MHz (Same as Class-A)
Update Interval	Variable by ship speed and course	2-step fixing by ship speed
	Ships status "at anchour" and not moving faster than 3 kt	3 min.
	Ships status "at anchour" and moving faster than 3 kt	10 sec.
	Ships operating in SOLAS mode, moving 0 - 14 kt	10 sec.
	Ship operating in SOLAS mode, moving 0 - 14 kt and changing course	3 1/3 sec.
	Ship operating in SOLAS mode, moving 14 - 23 kt	6 sec.
	Ship operating in SOLAS mode, moving 14 - 23 kt and changing course	2 sec.
	Ship operating in SOLAS mode, moving faster 23 kt	2 sec.
	Ship operating in SOLAS mode, moving faster 23 kt and changing course	2 sec.
		Moving less than 2 kt: 3 min. Moving faster than 2 kt: 30 sec.

- ▶ Fully satisfies the technical standards for Class-B AIS, IEC 62287-1
- ▶ Receives both Class-A and Class-B AIS information
- ▶ Enhances safe navigation by exchanging critical navigation information from AIS-equipped vessels nearby
- ▶ Greatly improves the level of the situational awareness even in fog, darkness or congested waterways
- ▶ Outputs data to NavNet 3D, NavNet vx2 and PC through Ethernet
- ▶ Flexible integration with various AIS compatible radar and chart plotters
- ▶ AIS Viewer software for PC (Standard supply)
- ▶ Sturdy design mounts easily on a bulkhead

an exchange that can be utilized



Information to be received

Dynamic Data

- Ship's position
- Coordinated universal time (UTC)
- Course over ground (COG)
- Speed over ground (SOG)
- Rate of turn (ROT)
- Heading
- Navigation status*

Static Data

- MMSI (Maritime Mobile Service Identity)
- IMO number*
- Ship's name
- Type of ship
- Call sign
- Length and beam
- Location of position-fixing antenna on the ship

Voyage Related Data

- Ship's draft*
- Hazardous cargo
- Destination and ETA*

Safety-related messages

* Class-A AIS only

Information to be transmitted

Dynamic Data

- Ship's position
- Coordinated universal time (UTC)
- Course over ground (COG)
- Speed over ground (SOG)
- Heading

Static Data

- MMSI (Maritime Mobile Service Identity)
- Ship's name
- Type of ship
- Cargo
- Call sign

- Length and beam
- Location of position-fixing antenna on the ship

Fixed form of safety-related messages

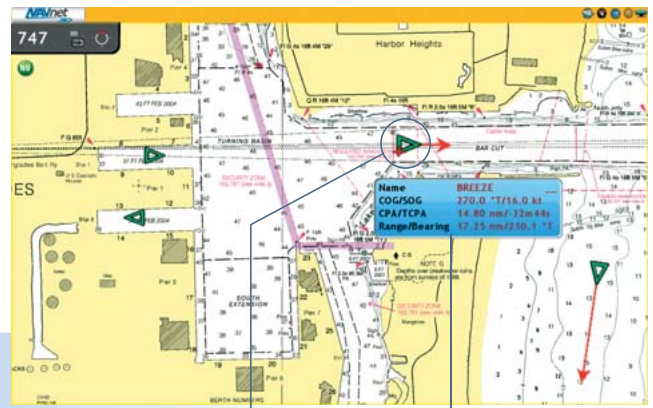

AIS target

AIS information

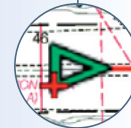

Name	BREEZE
COG/SOG	270.0 °T/16.0 kt
CPA/TCPA	14.80 nm/32m44s
Range/Bearing	17.25 nm/210.1 °T



NavNet vx2 can also be interfaced to the FA-30



When placing a cursor onto the AIS target, an AIS data window will pop up to display the following data of the target: Ship's name, COG, SOG, CPA, TCPA, Range and Bearing.



AIS Viewer for PC (Standard supply)

The software can be upgraded to a full version of MaxSea Navigation Software or MaxSea-NavNet Software.

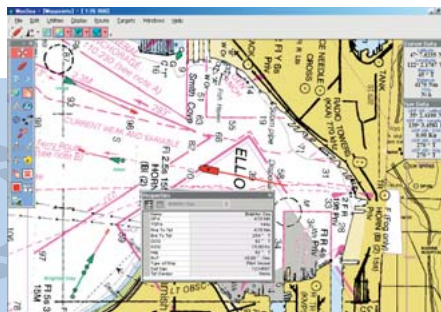

AIS info on NOAA chart

Rough raster chart is already installed. Also, additional charts can be installed into this viewer.

COG/SOG vector



Past track line

Display Options	
+	Brighter Day
Name	Brighter Day
CPA	4.70 Nm
TCPA	+46p
Ring To Text	4.70 Nm
Brng To Text	264 ° T
COG	62 ° T
SOG	16.00 Kn
Heading	62 ° T
ROT	+0.00 ° /min
Type of Ship	Plot Vessel
Call Sign	1234567
Txt Danger	None

AIS target data for the selected vessel



Radar FR-8xx2 series

When interfacing with FR-8xx2 series, optional AIS interface IF-1500AIS is needed.



AIS target

AIS information

AIS target symbol

COG/SOG vector changes its length according to SOG. ROT mark is viewable when the target vessel sends the information. Past track dots enables you to evaluate the target's action.

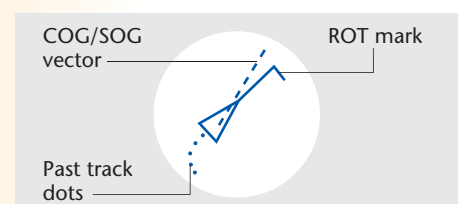

SPECIFICATIONS OF FA-50

STANDARDS

IMO MSC.140(76), IEC 62287-1, ITU-R M.1371-2,
DSC ITU R M.825-3, IEC 60945 Ed.4

TRANSPONDER UNIT

TX/RX Frequency 156.025 MHz to 162.025 MHz

GPS RECEIVER

Receiving Channels 12 channels parallel, 12 satellites tracking
Rx Frequency 1575.42 MHz
Rx Code C/A code
Position Accuracy 10 m (HDOP ≤ 4)

INTERFACE

COM RS-422/IEC 61162-1
Ethernet 10/100BASE-T
Input: ACK, BBM, DTM, GBS, GGA, GLL, GNS, HDT, OSD, RMC, SSD, VBW, VSD, VTG, AIQ, DSC, DSE, PFEC
Output: VDM, VDO, ABK, ACA, ACS, ALR, TXT, PFEC

POWER SUPPLY 12-24 VDC 2.0-1.0 A

ENVIRONMENT

Temperature

Transponder Unit: -15 to +55°C
Antenna Unit: -30 to +70°C

Waterproofing

Transponder Unit: IP20
Antenna Unit: IPx6

EQUIPMENT LIST

Standard

1. AIS Transponder FA-50
2. GPS Antenna GPA-017S or GPS/VHF Combined Antenna GVA-100-T with Distribution Box DB-1 (Optional VHF antenna is needed.)
3. AIS Viewer FAISPC-MX
4. Installation Materials and Spare Parts

Option

1. VHF Antenna 150M-W2VN
2. Antenna Cable Set (30/50 m)
3. Antenna Base
4. Power Supply Unit PR-240
5. LAN Cable (2/10 m) for the connection with a PC
6. LAN Cable (1/5/10/20/30 m) for the connection with NavNet vx2

AIS TRANSPONDER FA-50

1.7 kg 3.7 lb

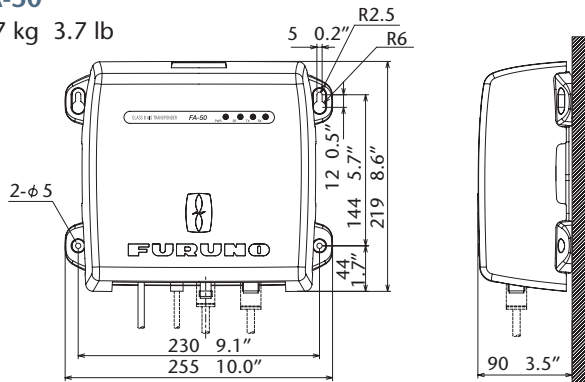

GPS/VHF Combined Antenna GVA-100-T

3.3 kg 7.3 lb

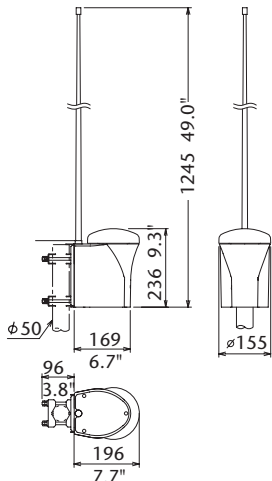

GPS Antenna GPA-017S

0.15 kg 0.3 lb

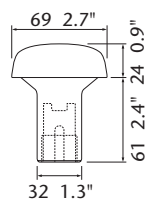

INTERCONNECTION DIAGRAM

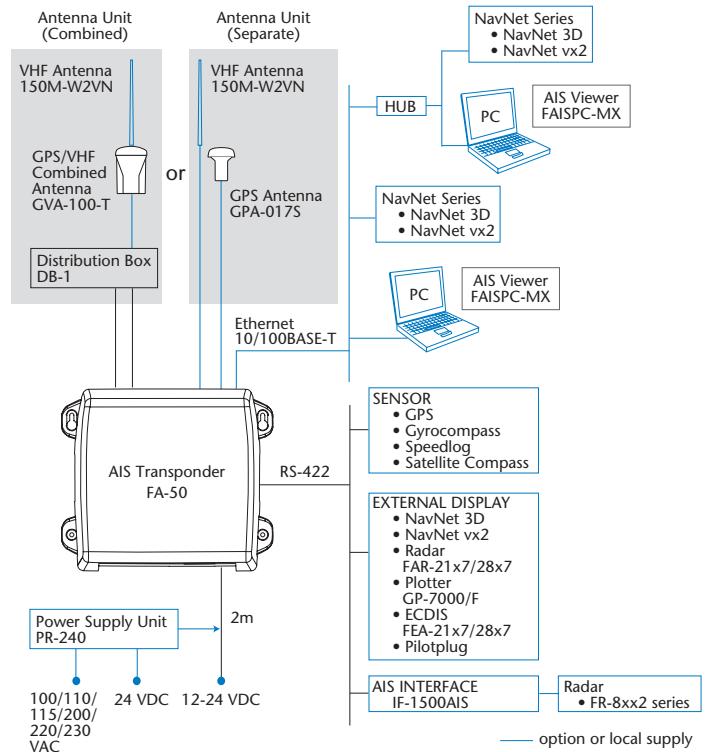

* Usually FA-50 uses the internal GPS. When connecting the external GPS, use one which satisfies the followings.

- 1) Outputs DTM sentence. (WGS-84 can be chosen.)
- 2) Outputs GBS sentence.
- 3) Outputs sentences with the mode indicator;
GNS: Ver. 3.0 or later GLL: Ver. 2.0 or later GGA: Ver. 2.0 or later RMC: Ver. 1.5 or later
4) The measured result of internal and external GPSs should be within 26 m. (These antenna should be located within 6 m.)

TRADEMARK REGISTERED MARCA REGISTRADA
SPECIFICATIONS SUBJECT TO CHANGE WITHOUT NOTICE

FURUNO ELECTRIC CO., LTD.
Nishinomiya, Hyogo, Japan
Phone: +81 (0)798 65-2111
Fax: +81 (0)798 65-4200, 66-4622

FURUNO U.S.A., INC.
Camas, Washington, U.S.A.
Phone: +1 360-834-9300
Fax: +1 360-834-9400

FURUNO (UK) LIMITED
Havant, Hampshire, U.K.
Phone: +44 23 9244 1000
Fax: +44 23 9248 4316

FURUNO FRANCE S.A.
Bordeaux-Mérignac, France
Phone: +33 5 56 13 48 00
Fax: +33 5 56 13 48 01

FURUNO ESPAÑA S.A.
Madrid, Spain
Phone: +34 91-725-90-88
Fax: +34 91-725-98-97

FURUNO DANMARK AS
Hvidovre, Denmark
Phone: +45 36 77 45 00
Fax: +45 36 77 45 01

FURUNO NORGE A/S
Ålesund, Norway
Phone: +47 70 102950
Fax: +47 70 102951

FURUNO SVERIGE AB
Västra Frölunda, Sweden
Phone: +46 31-7098940
Fax: +46 31-497093

FURUNO FINLAND OY
Espoo, Finland
Phone: +358 9 4355 670
Fax: +358 9 4355 6710

FURUNO POLSKA Sp. z o.o.
Gdynia, Poland
Phone: +48 58 669 02 20
Fax: +48 58 669 02 21

FURUNO DEUTSCHLAND GmbH
Rellingen, Germany
Phone: +49 4101 838 0
Fax: +49 4101 838 111

LLC "FURUNO EURUS"
St. Petersburg, Russian Federation
Phone: +7 812 767 15 92
Fax: +7 812 766 55 52



07125U Printed in Japan
Catalogue No. N-868

