

INTERCONNECTION DIAGRAM

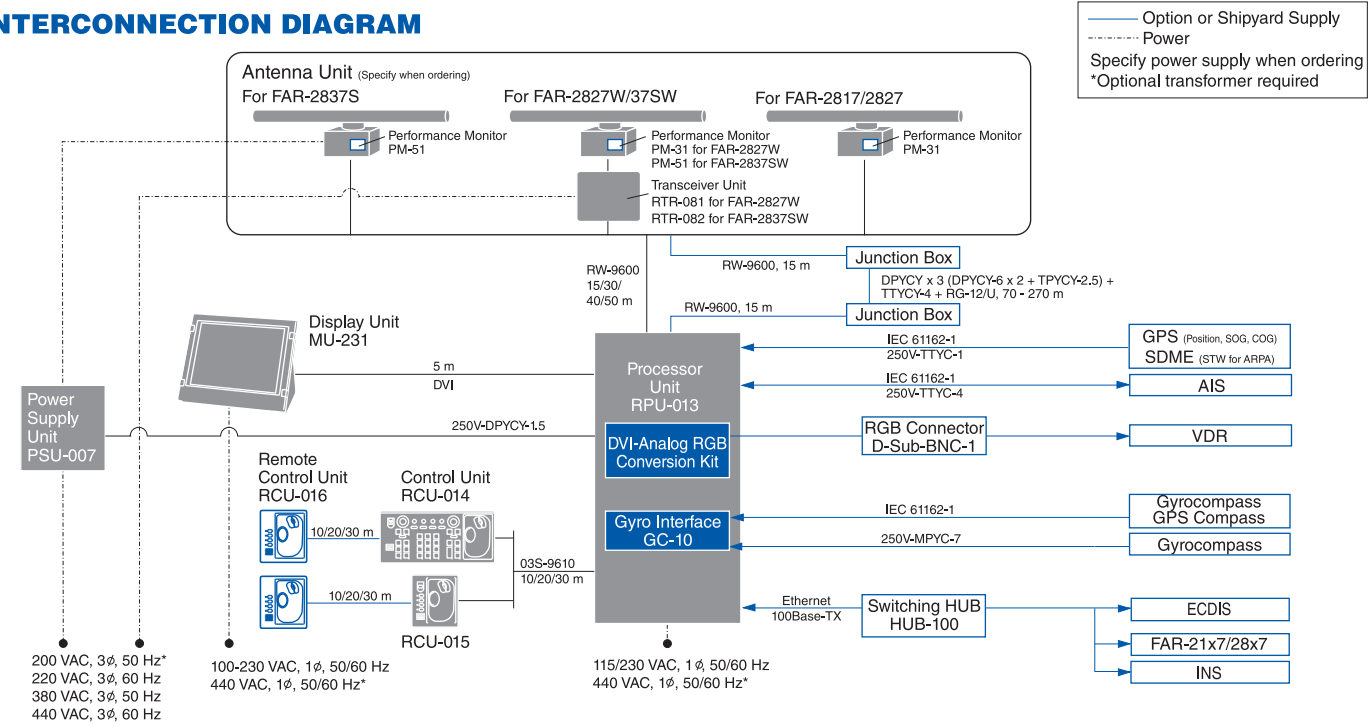

Antenna Unit for FAR-2817/2827/2827W

XN-12AF 33 kg 73 lb

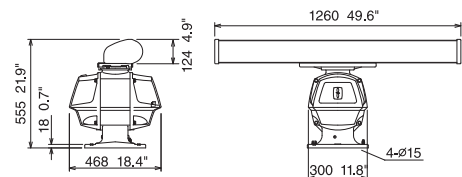

XN-20AF 39 kg 86 lb

XN-24AF 42 kg 93 lb

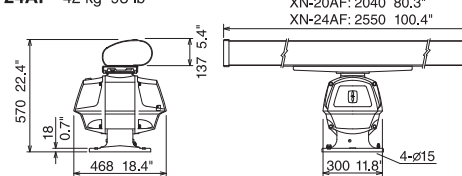

Display Unit MU-231

12.8 kg 28.22 lb

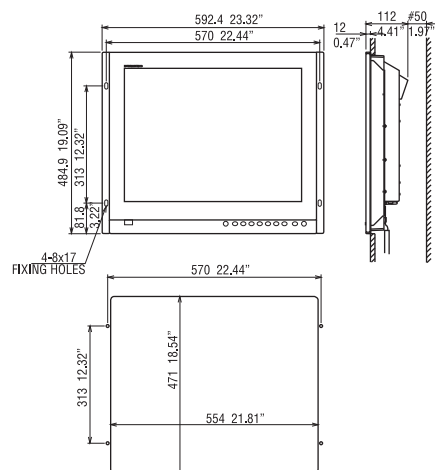

Antenna Unit for FAR-2837S/2837SW

SN-36AF 133 kg 293.2 lb

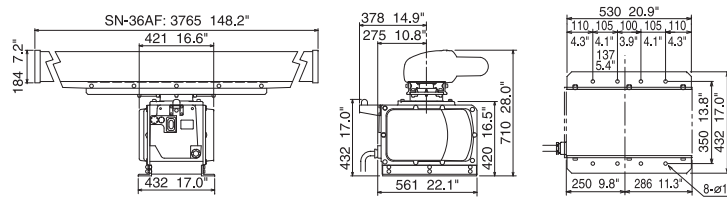

Transceiver Unit for FAR-2827W

RTR-081 8.0 kg 17.6 lb

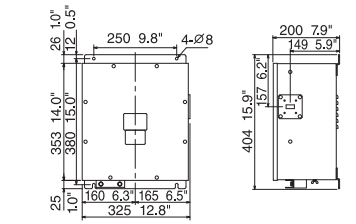

Transceiver Unit for FAR-2837SW

RTR-082 17.0 kg 37.5 lb

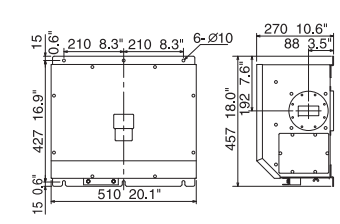

Processor Unit RPU-013

10 kg 22 lb

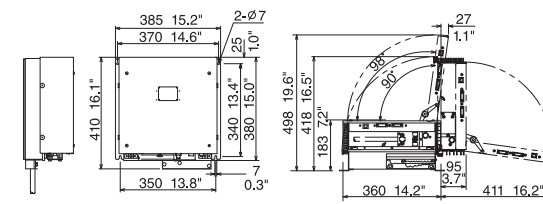

Control Unit Full-keyboard type RCU-014

3.7 kg 8.2 lb

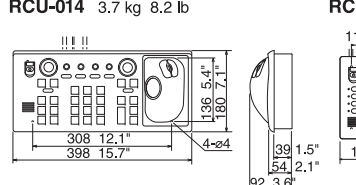

Trackball type RCU-015

2.4 kg 5.3 lb

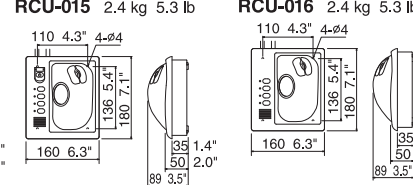

Remote Control Unit RCU-016

2.4 kg 5.3 lb

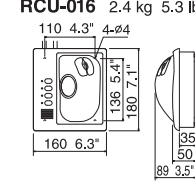

RADAR/ARPA

Automatic Radar Plotting Aid

23.1" High resolution Multi-color LCD
FAR-28x7 series



FURUNODEEPSEA.com

All brand and product names are registered trademarks, trademarks or service marks of their respective holders.

SPECIFICATIONS SUBJECT TO CHANGE WITHOUT NOTICE

FURUNO ELECTRIC CO., LTD.

Nishinomiya, Hyogo, Japan
 www.furuno.co.jp

FURUNO U.S.A. INC.

Camas, Washington, U.S.A.
 www.furunousa.com

FURUNO (UK) LIMITED

Havant, Hampshire, U.K.
 www.furuno.co.uk

FURUNO FRANCE S.A.S.

Bordeaux-Mérignac, France
 www.furuno.fr

FURUNO ESPAÑA S.A.

Madrid, Spain
 www.furuno.es

FURUNO DANMARK AS

Hvidovre, Denmark
 www.furuno.dk

FURUNO NORGE A/S

Ålesund, Norway
 www.furuno.no

FURUNO SVERIGE AB

Västra Frölunda, Sweden
 www.furuno.se

FURUNO FINLAND OY

Espoo, Finland
 www.furuno.fi

FURUNO POLSKA Z o.o.

Gdynia, Poland
 www.furuno.pl

FURUNO EURUS LLC

St. Petersburg, Russian Federation
 www.furuno.com.ru

FURUNO DEUTSCHLAND GmbH

Rellingen, Germany
 www.furuno.de

FURUNO HELLAS S.A.

Piraeus, Greece
 RICO (PTE) LTD

Singapore
 www.rico.com.sg

11043SS Printed in Japan

Catalogue No. R-199a



FURUNODEEPSEA.com

FURUNO has integrated leading-edge technology with a user-friendly interface, providing reliable performance and simplified installation

RADAR/ARPA
Automatic Radar Plotting Aid



The revolutionary FAR-28x7 series of X- and S-band, TR-up and -down radars are the result of FURUNO's 50 years of experience in marine electronics and advanced computer technology. This series is designed to meet the exacting standards of the International Maritime Organization (IMO) for all ships.

The display unit employs a 23.1" LCD which provides an effective picture diameter of larger than 340 mm. The high-resolution UXGA, digital flat-panel display unit provides crisp and clear radar images through a DVI interface. The DVI interface provides a pure digital video signal by using a digital signal for the entire path which maintains the image quality at the highest level, because the signal is not degraded as a result of a digital-to-analog conversion. The display has selectable color with a day and night background colors for clear presentation in all lighting conditions. Different colors are assigned for marks, symbols and text for easy observation.

Target detection is improved by sophisticated signal processing techniques featuring superb short-range detection. Two guard zones are provided as automatic acquisition zones for ARPA (TT function). One of two can be set at required ranges and any sector in any form. The FAR-28x7 series can display data about AIS-equipped ships, when connected with an AIS transponder. AIS enhances detection of other ships and AtoN (Aid to Navigation) on radar by displaying their movement and status with easy to read symbols and text.

The radar antenna is available with 4, 6.5, or 8 feet radiator. For the X-band, the rotation speed is selectable from 24 rpm for standard radar or 42 rpm for HSC. The S-band radar is also available with the antenna radiator of 12 feet, and the rotation speed is selectable from 21/26 rpm for standard radar or 45 rpm for HSC application. The S-band radar assures target detection in adverse weather where an X-band is heavily affected by sea or rain clutter.

X-band antenna for FAR-2817/2827/2827W



8 ft antenna
(4 or 6.5 ft also available)



S-band antenna for FAR-2837S/2837SW



12 ft antenna



FAR-2817:	X-band, 12 kW, TR up
FAR-2827:	X-band, 25 kW, TR up
FAR-2827W:	X-band, 25 kW, TR down
FAR-2837S:	S-band, 30 kW, TR up
FAR-2837SW:	S-band, 30 kW, TR down



FAR-28x7 series radar

- ▶ Advanced signal processing for improved target detection
- ▶ High resolution UXGA LCD provides crisp radar images
- ▶ Complies with the existing IMO standards for all ships
- ▶ Low spurious magnetrons meeting ITU-R unwanted emission standards
- ▶ Up to four radars can be interswitched in the network without an extra device
- ▶ Automatic plotting/tracking of 100 targets manually or automatically acquired
- ▶ Displays 1000 AIS-equipped targets
- ▶ Easy operation by customizable function keys, trackball/wheel palm module and rotary controls
- ▶ Stylish streamlined design

This series of radar complies with the latest IMO and IEC regulations:

- IEC 60945
- IEC 61162
- IEC 61993
- IEC 62388
- IMO MSC.191(79)
- IMO MSC.192(79)
- IMO A.694(17)
- IMO A.813(19)
- IMO SN/Circ.217

Utilizing a high speed Ethernet network, the FAR-28x7 series brings flexible system expansion and consolidation to onboard navigation systems

FEATURES of FAR-28x7 series

► 100 Base-TX Ethernet Network System

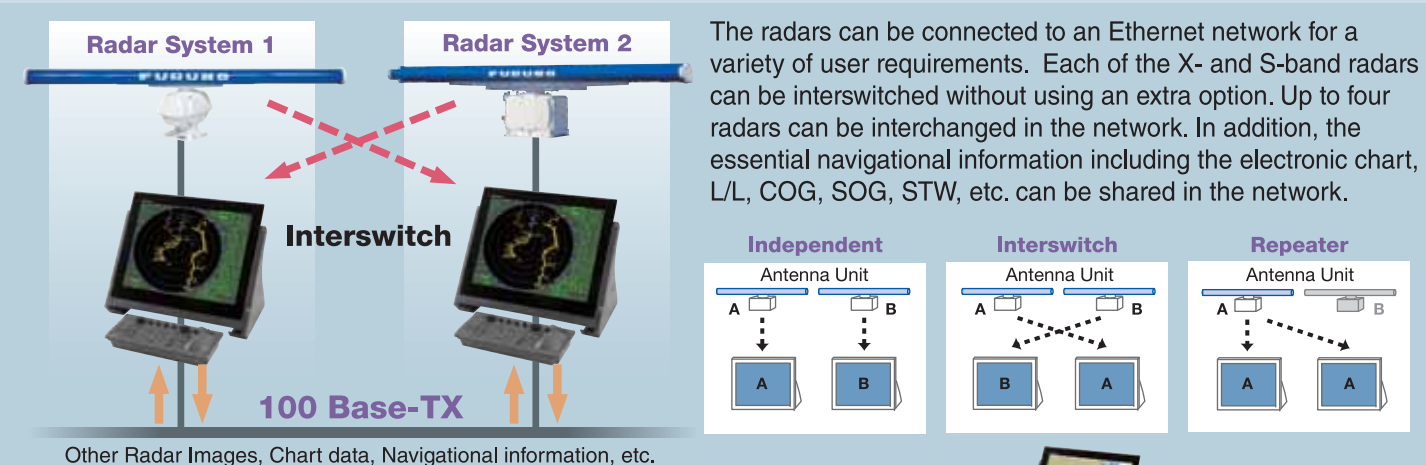

The 100 Base-T Ethernet is utilized to link up to four sets of radar/ARPA FAR-21x7/28x7 with the ECDIS FEA-2107/2807. This link gives high-speed navigational data sharing within the system and allows operators to choose either a single station system or a total Integrated Navigation System (INS).

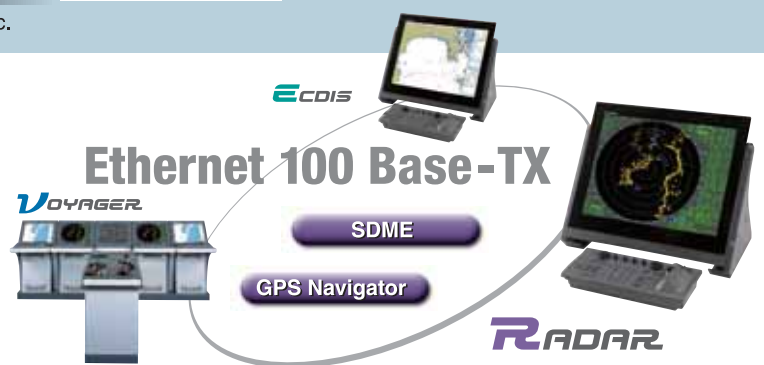

► Stress-free operation with versatile control units

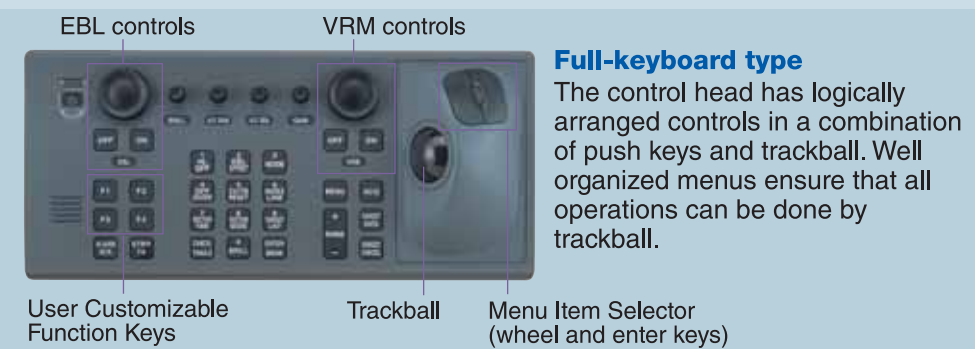

FUNCTIONS of FAR-28x7 series

► ARPA (TT)/AIS

Targets automatically acquired. AIS-equipped target selected for data reading.

Own ship data cell		
DATA Cell 1	Tracking data	Water temp, Depth, Wind
DATA Cell 2	Tracking data	Zoom
DATA Cell 3	Tracking data	AIS Information

Target Association (Fusion)

An AIS-equipped ship may be displayed by both AIS and ARPA (TT) symbols. This is because the AIS position is measured by a GPS navigator in L/L while the ARPA (TT) target blip and data are measured by range and bearing from own ship. When the symbols are within an operator-set criteria, the ARPA (TT) symbol is merged with the AIS symbol. The criteria is determined by the differences in range, bearing, course, speed, etc.

Symbols for AIS

AIS COG/SOG vector changes its length with speed. ROT mark is viewable at the COG/SOG vector tip when a target ship is equipped with a FURUNO satellite compass SC-50/110 or gyrocompass which can talk ROT serial sentence.

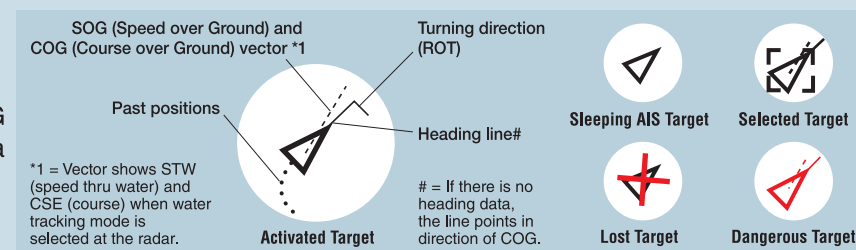

Guard Zones

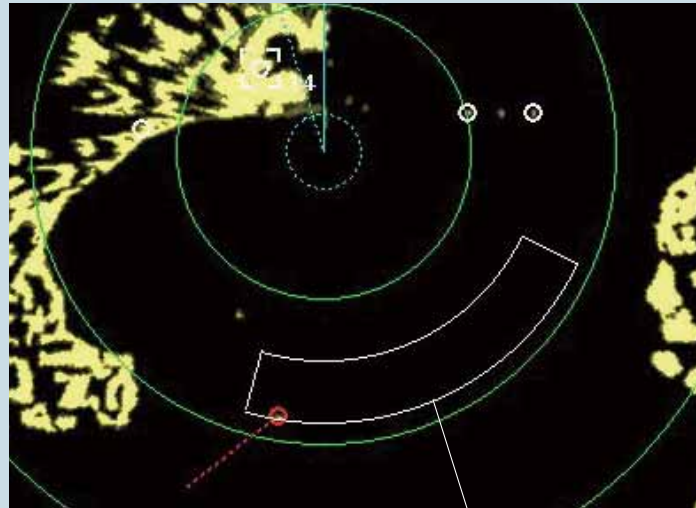

Guard Zones

Automatic Acquisition Zone

Two automatic acquisition zones may be set in a sector or any form. They also act as suppression zones, avoiding unnecessary overloading to the processor and clutter by disabling automatic acquisition and tracking outside them. Targets in an automatic acquisition zone are shown with an inverse triangle. The operator can manually acquire important targets without restriction.

Guard Zones and Anchor Watch Zone

Guard Zones generate visual and audible alarms when targets enter the operator set zones. One of the Guard Zones may be used as an anchor watch to alert the operator when own ship or targets drift away from the set zone.

CPA Alarm

The target tracking symbol changes to a triangle when its predicted course (vector) violates the operator set CPA/TCPA. The operator can readily change the vector lengths to evaluate the target movement trend.

Symbols for ARPA (TT)

Past Position Display
The ARPA (TT) displays equally time-spaced dots marking the past positions of any targets being tracked. A new dot is added during preset time intervals until the preset number is reached. AIS also displays past position dots.

Target Trails

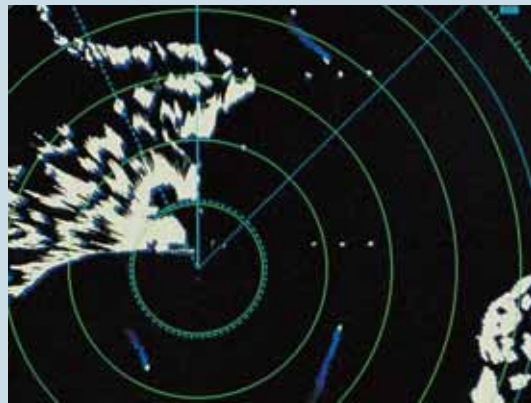

The target trails feature generates a monotone or gradual shading afterglow on all objects on the display. The trails are useful in showing own ship movement and other ship tracks in a specific fishing operation. The unique feature in this radar is a choice of True or Relative mode in Relative Motion (only True in TM). When changing modes, trails remain on the screen.

Chart Overlay



This radar incorporates a VideoPlotter that displays electronic charts, plots own and other ship's track, enables entry of waypoints/routes, and makes a radar map. The Radar targets are overlaid on the chart. (For non-SOLAS ships only)

Radar Map

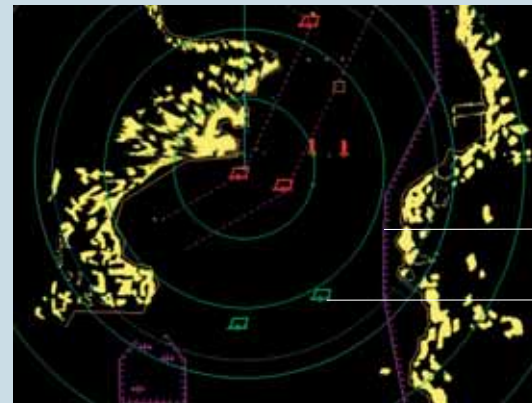

A radar map is a combination of lines and marks whereby the user can define and input the navigation area, route planning and monitoring data. The radar map can include up to 20,000 points for lines and marks. The map data can be saved to facilitate repeated use on a routine navigation area. Planned routes created on ECDIS can be transferred onto a radar display when interfaced with ECDIS.

Presentation Colors

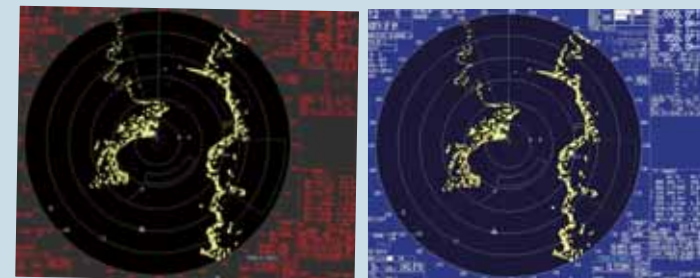

Antenna Radiators

1. Type Slotted waveguide array
2. Beamwidth and sidelobe attenuation

Radiator Type	X-Band			S-Band
	XN-12AF	XN-20AF	XN-24AF	SN-36AF
Length	4 ft	6.5 ft	8 ft	12 ft
Beamwidth(H)	1.9	1.23	0.95	1.8
Beamwidth(W)	20	20	20	25
Sidelobe (within 10)	-24 dB	-28 dB	-28 dB	-24 dB
Sidelobe (outside 10)	-30 dB	-32 dB	-32 dB	-30 dB

3. Rotation

X-Band		S-Band
Rotation	24 rpm	42 rpm
Gear Box	RSB-096/103	RSB-097
S-Band		S-Band
Rotation	21/26 rpm	45 rpm
Gear Box	RSB-098/099/104/105	RSB-100/101/102

RF Transceiver

1. Frequency
X-band: 9410 MHz 30 MHz
S-band: 3050 MHz 30 MHz
2. Output power

	FAR-2817	FAR-2827	FAR-2827W	FAR-2837S	FAR-2837SW
Output Power	12 kW	25 kW	25 kW	30 kW	30 kW
Transceiver	RTR-078	RTR-079	RTR-081	RTR-080	RTR-082

3. Pulselength/PRR

Range scale (nm)	Pulselength (s)	PRR (Hz)
0.125, 0.25	0.07	3000
0.5	0.07, 0.15	3000
0.75, 1.5	0.07, 0.15, 0.3	3000, 1500
3	0.15, 0.3, 0.5, 0.7	3000, 1500, 1000
6	0.3, 0.5, 0.7, 1.2	1500, 1000, 600
12, 24	0.5, 0.7, 1.2	1000, 600
48, 96	1.2	600

4. I.F. 60 MHz, Logarithmic
5. Bandwidth
Short pulse: 40 MHz
Middle pulse: 10 MHz
Long pulse: 3 MHz

RADAR DISPLAY

1. Display
23.1" color LCD (UXGA 1600 x 1280 pixels),
470 (H) x 353 (V) mm,
Effective display diameter: 341 mm
Echo Color: Yellow, green or white in 32 levels
2. Range scales and ring intervals (nm)
Range | .125, .25, .5, .75, 1.5, 3, 6, 12, 24, 48, 96
Ring | .025, .05, .1, .25, .5, 1, 2, 4, 8, 16
3. Minimum range
22 m
4. Range discrimination
26 m
5. Range ring accuracy
Within ±1 % of the current range scale or 10 m, whichever the greater
6. Presentation modes
Head-Up, Cursor-gyro, North-Up, Course-Up, True Motion (sea or ground stabilization)
7. Heading information
GPS compass SC-50/110 is a recommended heading sensor as a backup for a gyrocompass. Confirm if your Administrations permit its use.
8. Parallel index lines
1, 2, 3 or 6 lines (menu selectable)
9. Radar map
20,000 points to create coastlines, own ship safety contour, isolated underwater dangers, buoys, traffic routing systems, prohibited areas and fairways as required by IMO.

Target Tracking

1. Acquisition
Auto or manual acquisition: 100 targets in 0.2-24 (32) nm
2. Tracking
Auto tracking on all acquired targets
3. Guard zone (Target Acquisition Area)
0.5 nm width sector, within 3-6 nm, desired bearing
1 nm width sector or polygon, desired range and bearing
4. Past positions
5 or 10 past positions on all targets
5. Collision warning
CPA Limit: 0.1-20 nm, TCPA Limit: 1-60 minutes
6. Trial maneuver
Dynamic or static, with selected delay time.

AIS FUNCTIONS (Data input from AIS is required)

1. Number of Targets
1,000 targets max.
2. Past Position Plot Intervals
OFF, 30 s, 1-60 minutes

POWER SUPPLY (specify when ordering)

1. Processor Unit
FAR-2817
100-115 VAC: 2.6 A (3.0 A for HSC), 220-230 VAC: 1.6 A (1.7 A for HSC), 1 ø, 50/60 Hz
FAR-2827
100-115 VAC: 3.0 A (3.4 A for HSC), 220-230 VAC: 1.8 A (1.9 A for HSC), 1 ø, 50/60 Hz
FAR-2827W
100-115 VAC: 3.2 A, 220-230 VAC: 1.6 A, 1 ø, 50/60 Hz
FAR-2837S/2837SW
100-115 VAC: 3.0 A, 220-230 VAC: 1.5 A, 1 ø, 50/60 Hz
2. Display Unit
100-230 VAC, 0.9 A, 1 ø, 50/60 Hz
440 VAC, 1 ø, 50/60 Hz with optional transformer RU-1803
3. Antenna Unit
FAR-2837S/2837SW:
200 VAC, 3.0 A, 3ø, 50 Hz; 220 VAC, 3.0 A (3.5 A for HSC*), 3ø, 60 Hz; 380 VAC, 1.5 A, 3ø, 50 Hz; 440 VAC, 1.5 A (1.7 A for HSC*), 3ø, 60 Hz
* for FAR-2837S only
110 VAC, 3ø, 60 Hz with RU-5693; 220 VAC, 3ø, 50 Hz with RU-6522; 440 VAC, 3ø, 50 Hz with RU-5466-1

EQUIPMENT LIST

- Standard**
1. Display Unit MU-231
 2. Processor Unit RPU-013
 3. Full-keyboard Control Unit RCU-014
Trackball Control Unit RCU-015
(Specify when ordering)
 4. Antenna Unit with cable (15/30/40/50 m)
 5. Power Supply Unit PSU-007 for FAR-2837S
 6. Standard Spare Parts and Installation Materials
- Option**
1. Performance Monitor PM-31 for X-band,
PM-51 for S-band
 2. Remote Control Unit RCU-016
 3. Gyro Interface GC-10
 4. DVI-Analog RGB Conversion Kit OP03-180 (SXGA output)
 5. RGB Connector DSUB-BNC-1 (for VDR)
 6. Memory Card Interface Unit CU-200
 7. Transformer RU-1803/5466-1/5693/6522
 8. Rectifier RU-3424/1746B
 9. Junction Box RJB-001
 10. Antenna Cable RW-9600
 11. Hand Grip FP03-09840
 12. Bracket FP03-09820
 13. Switching Hub HUB-100